

Satellite Telemetry: A New Tool for Wildlife Research and Management



UNITED STATES DEPARTMENT OF THE INTERIOR
Fish and Wildlife Service / *Resource Publication 172*

Resource Publication

This publication of the Fish and Wildlife Service is one of a series of semitechnical or instructional materials dealing with investigations related to wildlife and fish. Each is published as a separate paper. The Service distributes a limited number of these reports for the use of Federal and State agencies and cooperators. A list of recent issues appears on inside back cover.

Copies of this publication may be obtained from the Publications Unit, U.S. Fish and Wildlife Service, Matomic Building, Room 148, Washington, DC 20240, or may be purchased from the National Technical Information Service (NTIS), 5285 Port Royal Road, Springfield, VA 22161.

Library of Congress Cataloging-in-Publication Data

Satellite telemetry.

(*Resource publication* ; 172)

Bibliography: p.

1. Biotelemetry. 2. Earth stations (Satellite telecommunication) I. Fancy, Steve G. II. Series: *Resource publication* (U.S. Fish and Wildlife Service) ; 172.

S914.A3 no. 172a 333.95'4'0973 s 88-600161

[QH324.9.B5] [621.3815'2]

Satellite Telemetry: A New Tool for Wildlife Research and Management

By Steve G. Fancy
Larry F. Pank
David C. Douglas
Catherine H. Curby
Gerald W. Garner
Steven C. Amstrup
Wayne L. Regelin

UNITED STATES DEPARTMENT OF THE INTERIOR
FISH AND WILDLIFE SERVICE

Resource Publication 172
Washington, D.C. • 1988

Contents

	Page
Abstract	1
Overview of the Argos Data Collection and Location System	2
History of Tracking Wildlife by Satellite	4
Description of System Components	6
Satellite Transmitters	6
Satellites Used with the Data Collection and Location System	6
Satellite Orbits	9
Signal Acquisition and Transfer to Processing Centers	13
Location Determination	15
Applications to Wildlife Research and Management	19
Transmitter Manufacturers, Specifications, and Costs	19
Optimum Duty Cycles	22
Sensor Development and Calibration	24
Location Accuracy and Precision in Wildlife Applications	26
Reliability of Transmitter Packages	29
Real-time Processing with a Local User Terminal	31
Effects of the Collar on the Animal	33
Geographic Information Systems	33
Conclusions	36
Acknowledgments	37
References	38
Appendix A. Description of Software Package for Processing Argos Data	44
Appendix B. Data Retrieval	46
Argos File Types	46
Dispose Files	46
Telex Files	48
Ajour File	49
Argos Commands	49
Appendix C. Explanation of Satellite Orbital Elements	52
Appendix D. Glossary	53
Appendix E. Getting Started with Argos	54

Satellite Telemetry: A New Tool for Wildlife Research and Management

by

Steve G. Fancy,¹ Larry F. Pank,² David C. Douglas,²
Catherine H. Curby,¹ Gerald W. Garner,² Steven C. Amstrup,²
and Wayne L. Regelin³

Abstract

The U.S. Fish and Wildlife Service and the Alaska Department of Fish and Game have cooperated since 1984 to develop and evaluate satellite telemetry as a means of overcoming the high costs and logistical problems of conventional VHF (very high frequency) radio-telemetry systems. Detailed locational and behavioral data on caribou (*Rangifer tarandus*), polar bears (*Ursus maritimus*), and other large mammals in Alaska have been obtained using the Argos Data Collection and Location System (DCLS). The Argos system, a cooperative project of the Centre National d'Études Spatiales of France, the National Oceanic and Atmospheric Administration, and the National Aeronautics and Space Administration, is designed to acquire environmental data on a routine basis from anywhere on earth. Transmitters weighing 1.6–2.0 kg and functioning approximately 12–18 months operated on a frequency of 401.650 MHz. Signals from the transmitters were received by Argos DCLS instruments aboard two Tiros-N weather satellites in sun-synchronous, near-polar orbits. Data from the satellites were received at tracking stations, transferred to processing centers in Maryland and France, and made available to users via computer tape, printouts, or telephone links.

During 1985 and 1986, more than 25,000 locations and an additional 28,000 sets of sensor data (transmitter temperature and short-term and long-term indices of animal activity) were acquired for caribou and polar bears. Locations were calculated from the Doppler shift in the transmitted signal as the satellite approached and then moved away from the transmitter. The mean locational error for transmitters at known locations ($n = 1,265$) was 829 m; 90% of the calculated locations were within 1,700 m of the true location. Caribou transmitters provided a mean of 3.1 (± 5.0 SD) locations per day during 6 h of daily operation, and polar bear transmitters provided 1.7 (± 6.9 SD) locations during 12 h of operation every third day. During the first 6 months of operation, the UHF (ultra-high frequency) signal failed on three of 32 caribou transmitters and 10 of 36 polar bear transmitters.

A geographic information system (GIS) incorporating other data bases (e.g., land cover, elevation, slope, aspect, hydrology, ice distribution) was used to analyze and display detailed locational and behavioral data collected via satellite. Examples of GIS applications to research projects using satellite telemetry and examples of detailed movement patterns of caribou and polar bears are presented. This report includes documentation for computer software packages for processing Argos data and presents developments, as of March 1987, in transmitter design, data retrieval using a local user terminal, computer software, and sensor development and calibration.

¹U.S. Fish and Wildlife Service, Alaska Fish and Wildlife Research Center, 101 12th Avenue, Box 20, Fairbanks, Alaska 99701.

²U.S. Fish and Wildlife Service, Alaska Fish and Wildlife Research Center, 1011 E. Tudor Road, Anchorage, Alaska 99503.

³Alaska Department of Fish and Game, 1300 College Road, Fairbanks, Alaska 99701.

The ability to remotely locate and to obtain physiological or behavioral data from free-ranging animals through use of biotelemetry techniques has resulted in major advances in our understanding and management of wildlife populations. Radio-tracking of animals using equipment operating in the VHF (very high frequency) range of the electromagnetic spectrum has become commonplace and has provided information not attainable by other means. However, a major drawback of conventional VHF radio-tracking equipment, particularly in studies involving species that move long distances or inhabit remote or mountainous areas, is limited signal range. This limited range often results in small or incomplete data sets because data collection is constrained by the high cost of getting to the animal and problems with harsh weather, darkness, worker safety, and movements by the animal outside the primary search area.

The potential use of satellites for tracking and obtaining physiological and other data from animals has been recognized for many years, but the technology needed to construct accurate and reliable transmitters small enough to be attached to animals was not available until the early 1980's. The U.S. Fish and Wildlife Service has been researching the use of satellites to track wildlife since the mid-1970's when studies were initiated to track polar bears using the Nimbus satellite system (Kolz et al. 1980). Since that time, numerous technological advances, most notably the availability of the Argos Data Collection and Location System (DCLS) aboard Tiros-N weather satellites and the development of batteries with a high power density, have made it possible to develop an accurate, reliable, and cost-effective system for tracking animals by satellite.

This report has three main objectives. First, it is a reference guide for use of the Argos DCLS for tracking animals. We brought together material from numerous sources to help the reader understand the operation of the satellite system and its individual components. We present details on satellite transmitter design, acquisition, and deployment; data retrieval and analysis; prediction of satellite overpasses for any area; and sensor development and calibration. We explain procedures used by Argos to determine transmitter location, and we present data on accuracy of locations for various types of transmitters.

Second, this report presents results of our studies using the Argos DCLS to obtain locational and

behavioral data on approximately 60 animals, including polar bears (*Ursus maritimus*), caribou (*Rangifer tarandus*), muskoxen (*Ovibos moschatus*), and Dall sheep (*Ovis dalli*) in northern Alaska. These cooperative studies are being conducted by the U.S. Fish and Wildlife Service, the Alaska Department of Fish and Game, the Arctic National Wildlife Refuge, and the University of Alaska. We give examples of how the Argos system has been used to address a variety of research needs and explain procedures we use to process and display locational data using a geographic information system (GIS).

Third, this report describes a computer software package we developed for processing and displaying Argos data (Appendix A). These programs are available, for the cost of reproduction, to researchers using the Argos system to track animals.

On 1 April 1987, Argos introduced new software for processing satellite telemetry data and opened a second data-processing center in Landover, Maryland. Except where noted, the results presented here are based on data collected and analyzed before that date. Modifications and additions to the previous system are noted throughout the text.

We also present preliminary findings from current research projects. The use of satellites to obtain data on free-ranging animals is expanding rapidly, and new developments and improved equipment become available almost monthly. Other researchers have used lightweight, solar-powered satellite transmitters to track large birds (Fuller et al. 1984; Strikwerda et al. 1985, 1986), and we are now testing new units on gray wolves (*Canis lupus*), mule deer (*Odocoileus hemionus*), and walrus (*Odobenus rosmarus*). Although the development of smaller, more accurate, and more durable satellite transmitters incorporating improved sensors is continuing, the technique of satellite telemetry should no longer be considered a risky, experimental approach, but rather an operational tool.

Overview of the Argos Data Collection and Location System

The Argos system is a cooperative project of the Centre National d'Études Spatiales (CNES) of France, the National Oceanic and Atmospheric Administration (NOAA), and the National Aeronautics and Space Administration (NASA). The primary purpose of Argos is to collect environmental data (e.g., data used in meteorology, hydrology, ocean-

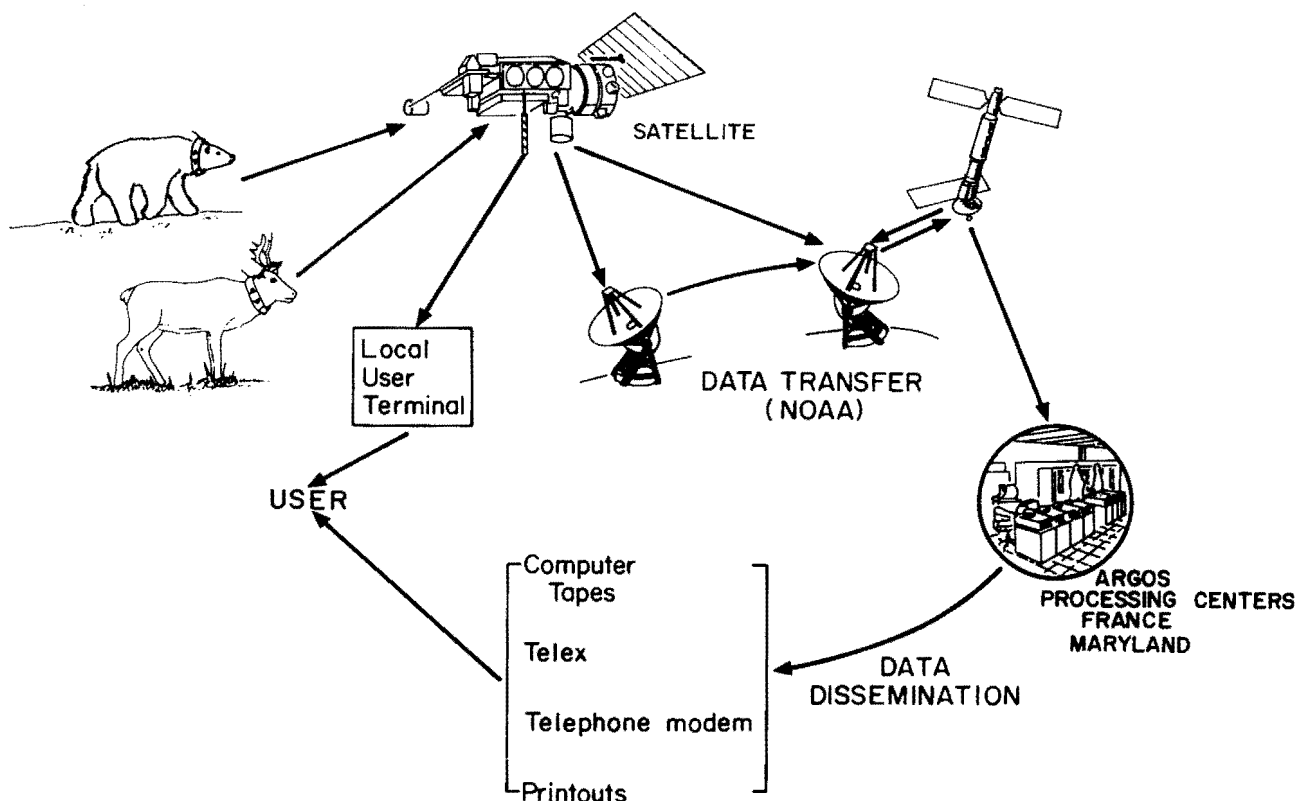

Fig. 1. Overview of the Argos Data Collection and Location System.

ography, ecology) on a routine basis from locations anywhere on earth but particularly those at latitudes greater than 60° . The system consists of a variety of transmitters located on ocean buoys, drifting ice, land sites, and, more recently, animals (Fig. 1); two polar-orbiting satellites (currently NOAA-9 and NOAA-10) that receive signals from transmitters during up to 28 overpasses per day; a network of satellite tracking stations and ground and satellite communication links that transfer satellite data to processing centers; and two data-processing facilities, one in Toulouse, France, and the other in Landover, Maryland, that distribute results to users.

The technical and administrative center of the Argos system, called Service Argos, is part of CLS (Collection and Location via Satellite) owned by the French space agency CNES, IFREMER (French institute for the exploration at sea), and French-owned banks. Argos became operational in 1978 with the launch of the Tiros-N satellite and is expected to continue well into the 1990's. Projects using the

Argos DCLS must be approved by the operations committee (a bilateral France-United States oversight organization), and users must pay for data-processing and dissemination services.

The Argos data-processing criteria and procedures were primarily designed for large transmitters operating within a narrow temperature range, for which the probability of each transmission being received by a satellite above the horizon is very high. Approximately 85% of currently deployed transmitters are on drifting or moored buoys, fixed land stations, or ships where transmitter size and weight do not impose major restrictions on transmitter design. Transmitters used on animals, on the other hand, must not only be small and lightweight but have a reasonable battery life and be able to withstand shock, abrasion, and exposure to the elements while on the animal. Furthermore, antennas must operate close to the animal's body. Service Argos has recently made several software changes designed to increase the utility of the system for animal tracking, and additional enhancements are planned.

History of Tracking Wildlife by Satellite

The first successful applications of satellites for obtaining locational and sensor data for wildlife used heavy, bulky instruments designed for oceanographic buoys and weather balloons. Craighead et al. (1972) deployed a 11.3-kg collar containing an Interrogation Recording Location System (IRLS) transponder on an adult female elk (*Cervus canadensis*) at the National Elk Refuge in Jackson Hole, Wyoming, in April 1970. The IRLS equipment transmitted twice each day to the Nimbus-3 and Nimbus-4 meteorological satellites. The elk remained within approximately 6 km of the capture site, and data were received for 29 days. Loss of communication between the transmitter and the satellite was attributed to the collar rotating around the elk's neck such that the antenna pointed down.

The Nimbus-3 satellite was also used to monitor temperatures and light intensity within the winter den of a black bear in February and March 1970 (Craighead et al. 1971). Equipment for this experiment was placed outside the den and was powered by two lead-acid automobile batteries.

In 1976, under contract to the U.S. Fish and Wildlife Service, Handar, Inc., began development of satellite transmitters for tracking polar bears. The resulting transmitter-harness package weighed 5.6 kg and was used to track three polar bears off the coast of Alaska using the Random Access Measurement System (RAMS) aboard the Nimbus-6 satellite beginning in March 1977 (Lentfer and DeMaster 1982). Initial tests with transmitters located on the ground or on captive bears at temperatures from -35°C to 5°C resulted in locational errors of 1 to 14 km (Kolz et al. 1980). Three instrument-equipped polar bears were tracked by satellite for 8, 20, and more than 228 days and travelled distances exceeding 330, 500, and 1,300 km, respectively, from their release sites north of Point Barrow, Alaska (Kolz et al. 1980).

In 1979, an additional 11 transmitters of the same design were used to track polar bears off the coasts of Alaska, the Northwest Territories, and Greenland in a cooperative project among agencies in the United States, Canada, Denmark, and Norway. Satellite transmitters were deployed on three female polar bears north of Point Barrow in late April and early May 1979, but one of the transmitters failed immediately after deployment, and a second pro-

vided only two locations during an 8-day period. The third transmitter was tracked for 150 days over a course exceeding 1,500 km, but some of this movement may have resulted after the bear slipped off her collar on a drifting ice pack. The two collars that failed soon after deployment had been in an airplane crash and may have been damaged (Taylor 1982).

Four transmitters were placed on adult female polar bears in Lancaster Sound, Northwest Territories (NWT), in May 1979 (Schweinsburg and Lee 1982). The transmitters operated for 8 h every 4 days, and were tracked by the Nimbus-6 satellite for 9 months, 8 months, 1 month, and 4 months, respectively. A total of 51 satellite locations over a 9-month period were received for the four bears.

A male and three adult female polar bears were fitted with satellite transmitters off the eastern coast of Greenland in April and May 1979 (Larsen et al. 1983). Two of the bears were tracked eastward to Svalbard and Frans Josef Land, and two moved southward with the East Greenland current. The bears were tracked for 18-63 days, with an average of 37 days.

Several experiments using the Nimbus-6 satellite to track pelagic species were also begun in the late 1970's. In 1978, Priede (1982) deployed four satellite transmitters on basking sharks (*Cetorhinus maximus*) off the coast of Scotland, but the transmitter assemblies failed soon after deployment and no data were received. Two experiments involving loggerhead sea turtles (*Caretta caretta*) towing a buoyant satellite transmitter were conducted by the U.S. Fish and Wildlife Service, the National Marine Fisheries Service, and the National Park Service off the coasts of Georgia and the Gulf of Mexico (Stoneburner 1982; Timko and Kolz 1982). The first tests with dolphins were begun in 1977, again using the Nimbus-6 and RAMS systems. Jennings and Gandy (1980) reported a mean locational error of 23 km for trials with captive dolphins. Two Hawaiian spotted dolphins (*Stenella attenuata*) were tracked by the Nimbus-6 satellite for 2 and 7 days in June 1981. The antenna broke off one unit, and the other unit failed after 2 days (Woods and Kemmerer 1982). No field data were received from the dolphins.

In July 1983, an Argos-certified satellite transmitter built by Telonics, Inc., was deployed on a humpback whale (*Megaptera novaeangliae*) entangled in a fishing net off Newfoundland (Mate et al. 1983). The whale was located 10 times over a 6-day period using data provided by a local user terminal at God-

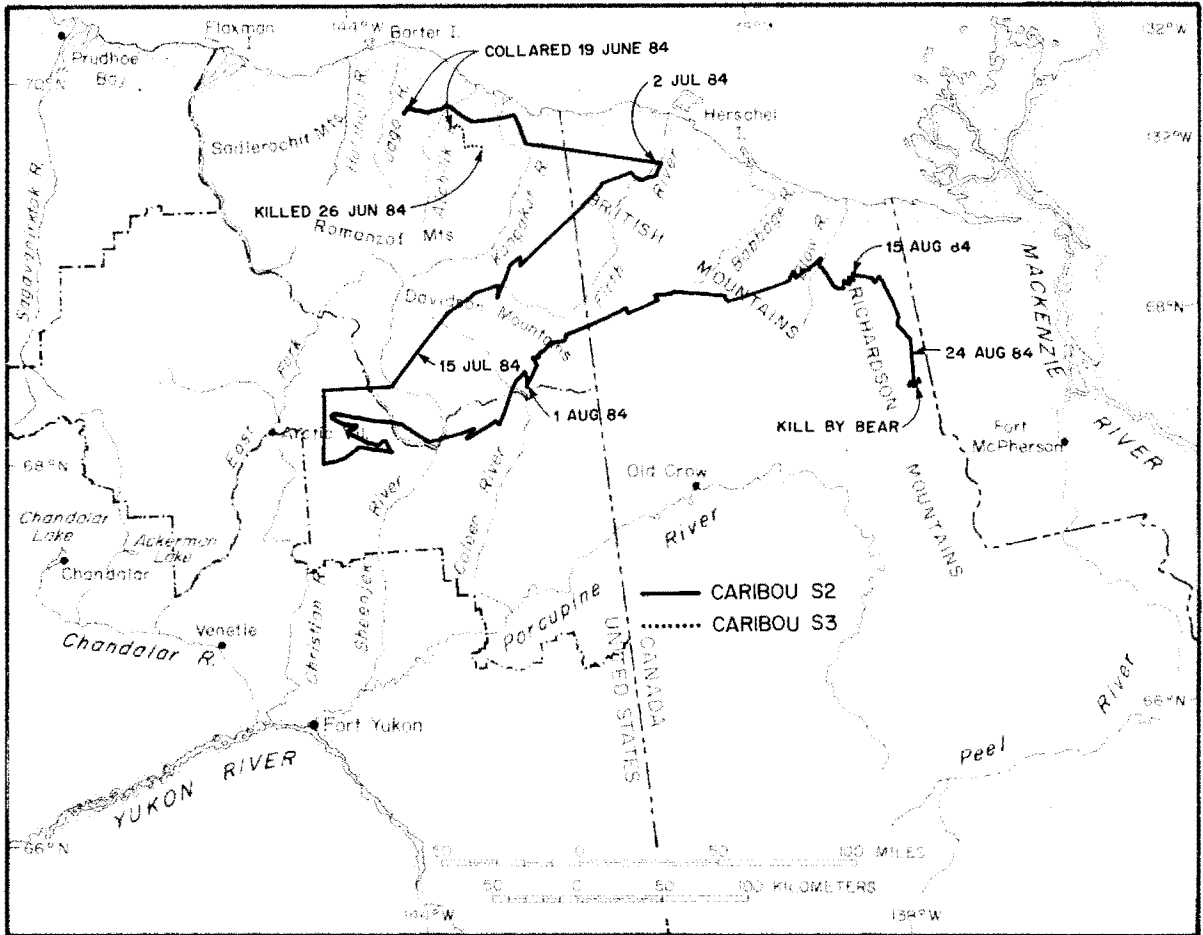

Fig. 2. Movements of two Porcupine Herd female caribou in 1984 as determined by first-generation satellite transmitters built by Telonics, Inc. (from Pank et al. 1985).

dard Space Flight Center and by Service Argos 4 weeks after the experiment.

Several different groups deployed Argos-compatible transmitters in 1984. Mate (unpublished data) obtained information on dive duration, dive depth, and temperature for a gray whale (*Eschrichtius robustus*) tagged in a lagoon in Mexico. The tag provided only 1 day of data, presumably because frequent contact between the tagged whale and other whales caused the attachment to fail. Satellite transmitters were deployed by Pank et al. (1985) on caribou of the Delta and Porcupine herds in Alaska (Fig. 2), by Curatolo (1986) on a caribou in the Kuparak oil field of northern Alaska, and by Craighead (1986) on two western Arctic-herd caribou. Reynolds (1986) used a Telonics satellite transmitter to obtain locational and activity data on a muskox on the coastal plain

of Alaska (Fig. 3). The Sea Mammal Research Unit in Great Britain deployed two transmitters built by Marinar Radar, Ltd., on sperm whales (*Physeter macrocephalus*), but one failed immediately after deployment and the other lasted only 12 h before it stopped transmitting (Tony Martin, Sea Mammal Research Inst., personal communication). Solar-powered satellite transmitters were deployed on swans in Alaska, a bald eagle (*Haliaeetus leucocephalus*) in Maryland, and Antarctic giant-petrels (*Macronectes giganteus*) in Antarctica (Strikwerda et al. 1986). Since these early experiments with the Argos system, numerous deployments of satellite transmitters have been made on caribou and polar bears (this study), West Indian manatees (*Trichechus manatus*; Mate et al. 1986; Rathbun et al. 1986), gray seals (*Halichoerus grypus*; Tony Martin, per-

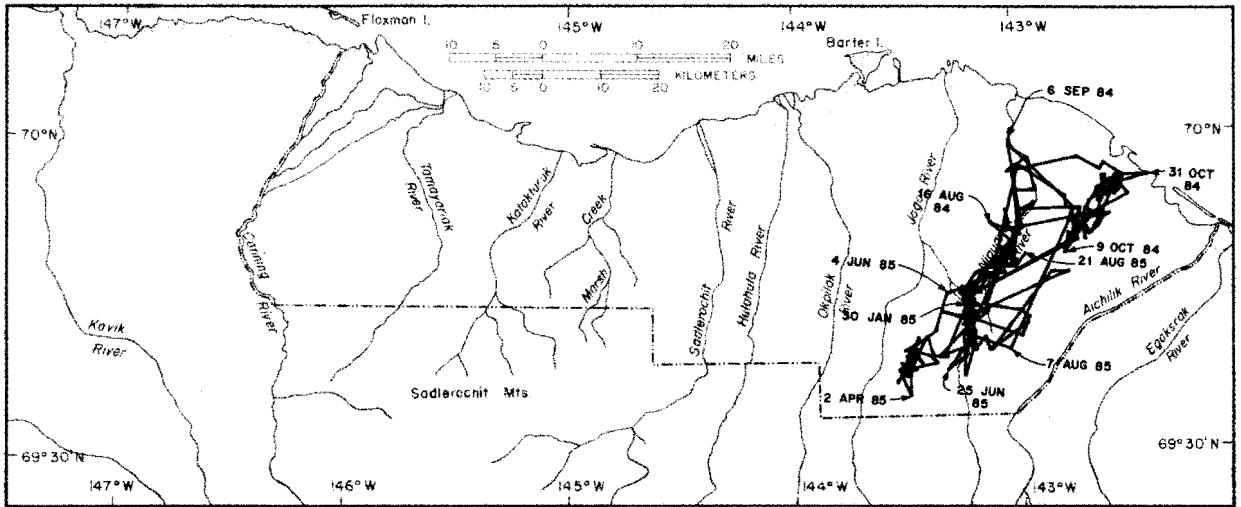

Fig. 3. Movements of a satellite-tracked muskox on the Arctic National Wildlife Refuge, Alaska, 1984–1985 (adapted from Reynolds 1986).

sonal communication), crabeater seals (*Lobodon carcinophagus*; R. Hill, Wildlife Computers, personal communication), brown bears (*Ursus arctos*; D. Craighead, personal communication), and several other species.

Description of System Components

Satellite Transmitters

Most transmitters monitored by the Argos DCLS are on ocean buoys, balloons, ships, and other large platforms. These transmitters, known as platform transmitter terminals (PTT's) are of two types: location PTT's, which are usually placed on moving objects and intended for collecting sensor data (e.g., air and water temperatures, wind speed) and location, and data-collection PTT's, which transmit only sensor data and often have a lower-quality oscillator because location is not required. Each PTT design must be certified by Service Argos before it can be used with the Argos DCLS. PTT's must meet stringent requirements (Table 1) intended to ensure that the PTT will not interfere with operation of other PTT's, is compatible with DCLS instruments onboard the satellites, is compatible with Argos Processing Center procedures, and provides locational accuracy in accord with system objectives. Each PTT must be equipped with a safety system capable of automatically switching the transmitter off in the event of a continuous transmission lasting more than 10 sec.

All PTT's operate on the same nominal frequency of 401.650 MHz. Platform location is determined from the Doppler shift in the frequency received at the satellite as it moves toward and then away from the PTT (see *Location Determination*). A PTT is identified by its unique code. Each transmission lasts between 360 and 920 ms and consists of an unmodulated and a modulated portion (Fig. 4). The unmodulated carrier lasts 160 ± 2.5 ms to allow the satellite receiver to lock onto the carrier. The short- and mid-term stability of this carrier frequency is an important determinant of location accuracy.

The modulated portion of the signal contains a 15-bit preamble to synchronize the Argos DCLS instruments with the message bit rate, an 8-bit synchronization word followed by one spare bit, 4 bits giving the number of 32-bit blocks of sensor data to follow, the PTT identification code assigned by Service Argos, and 32 to 256 bits of sensor data in blocks of 32 bits. This signal is transmitted every 40 to 60 seconds from location PTT's and every 60 to 200 sec from data-collection PTT's. The repetition period is assigned by Service Argos and depends on project objectives and geographic distribution of the PTT's to be deployed.

Satellites Used with the Data Collection and Location System

The National Environmental Satellite Service (NESS) of NOAA operates a network of geosta-

Table 1. *Specifications for transmitters to be used with the Argos DCLS. Adapted from Argos Platform Transmitter Terminals General Specifications, Service Argos.*

Measured parameter	Specification
I. Transmitted power	
Transmission output power (P_N)	According to antenna type
Power stability during transmission (P_N)	0.5 dB
Power rise and cut-off time	1 ms
II. Transmission frequency	
Frequency rise characteristics	10^{-7}
Transmission frequency (f_0)	401.650 MHz \pm 1.2 KHz
Stability during transmission	2 Hz
Short-term (100 ms) stability	
location PTT's	10^{-9}
all PTT's	2×10^{-9}
Medium-term (20 min) stability	
location PTT's	4 Hz over 20 min
all PTT's	40 Hz over 20 min
Long-term (2 h) stability	
all PTT's	10^{-6}
III. Modulation signal	
Phase deviation $\Theta_1 + \Theta_2$	2.4 rad
Phase deviation Θ_1	1.1 ± 0.1 rad
Phase symmetry	4%
Modulation time rise	250 ms
IV. Message format and structure	
Unmodulated carrier duration	160 ± 2.5 ms
Transmission duration	360 ± 5 ms to $920 + 12$ ms (in steps of 80 ± 1 ms)
Repetition rate	$\pm 10\%$
Bit synchronization	15 bits "1"
Format synchronization	8 bits (00010111)
Initialization	1 bit "1"
Number of 32-bit groups	4 bits
Identification	20 bits
Bit rate	400 ± 5 Hz
V. Analysis of transmission spectrum	
Amplitude of spurious or harmonic rays relative to the unmodulated carrier:	
in the range 401.650 ± 0.02 MHz	-40 dB
outside the range	-30 dB
VI. Protection against continuous transmissions	operation check

tionary and polar-orbiting satellites for providing global data on the earth's environment on a daily basis. A primary mission of the geostationary satellites is to continuously monitor weather patterns in the temperate and tropical latitudes near the United States. Polar-orbiting satellites provide data used in the fields of meteorology, hydrology, oceanography, space environment monitoring, and biology and provide coverage of latitudes greater than 60°N that are not adequately covered by geostationary satellites.

The Argos DCLS instruments are carried aboard Tiros-N satellites operated jointly by the United States (NASA and NOAA), Great Britain (Ministry of Defence, Meteorological Office), and France (Centre National d'Études Spatiales and Centre d'Études de la Meteorologie Spatiale). NASA funded the development of Tiros-N, the first satellite of the series, and has procured and launched all subsequent satellites using NOAA funds. NOAA operates the ground facilities within the United States, including the two Command and Data Acquisition (CDA) stations

UNMODULATED CARRIER 160 ± 2.5ms	MODULATED CARRIER 360ms					
	PREAMBLE	FORMAT SYNC.	INITIALIZATION	NUMBER OF 32-BIT GROUPS	IDENTIFICATION CODE	SENSOR DATA
	15 bits ()	8 bits (00010111)	1 bit (= 1)	4 bits (0001)	20 bits	32 bits

Fig. 4. Format of the message sent by an Argos-compatible transmitter. The message shown is for a unit sending the minimum 4 bytes (32 bits) of sensor data (adapted from Argos 1984).

at Gilmore Creek, Alaska, and Wallops Island, Virginia, the satellite control center in Suitland, Maryland, and the data processing centers excluding those operated by Service Argos. Great Britain provides a Stratospheric Sounding Unit for each satellite, whereas France provides the DCLS and operates a ground receiving station in Lannion, France. Major instrument systems aboard the satellites include the Advanced Very High Resolution Radiometer, the Operational Vertical Sounder, the Space Environment Monitor, the Argos DCLS, and on more recent satellites, Search and Rescue Satellite Aided Tracking as well as Earth Radiation Budget Experiment instruments (Fig. 5, Table 2). The primary source of power for the spacecraft is the solar array, which rotates once per orbit to keep the array oriented toward the sun.

NASA launched Tiros-N on 13 October 1978 and it was followed into orbit on 27 June 1979 by NOAA-6, the first NOAA-funded satellite of the series (Table 3). The present operations plan is to have two operational satellites in orbit at all times, one that passes over a given area in the morning between 0600 h and 1000 h local time and one that passes over in the afternoon at about 1500 h local time. New satellites are given a letter designation before launch and are then numbered consecutively after launch. Satellites have an expected life-span of 2 years and will be launched at a rate of approximately one per year to maintain continuous operation. NOAA-8 replaced NOAA-6 in 1983, but because of an onboard clock failure, NOAA-6 had to be reactivated until NOAA-10 became fully operational in November 1986.

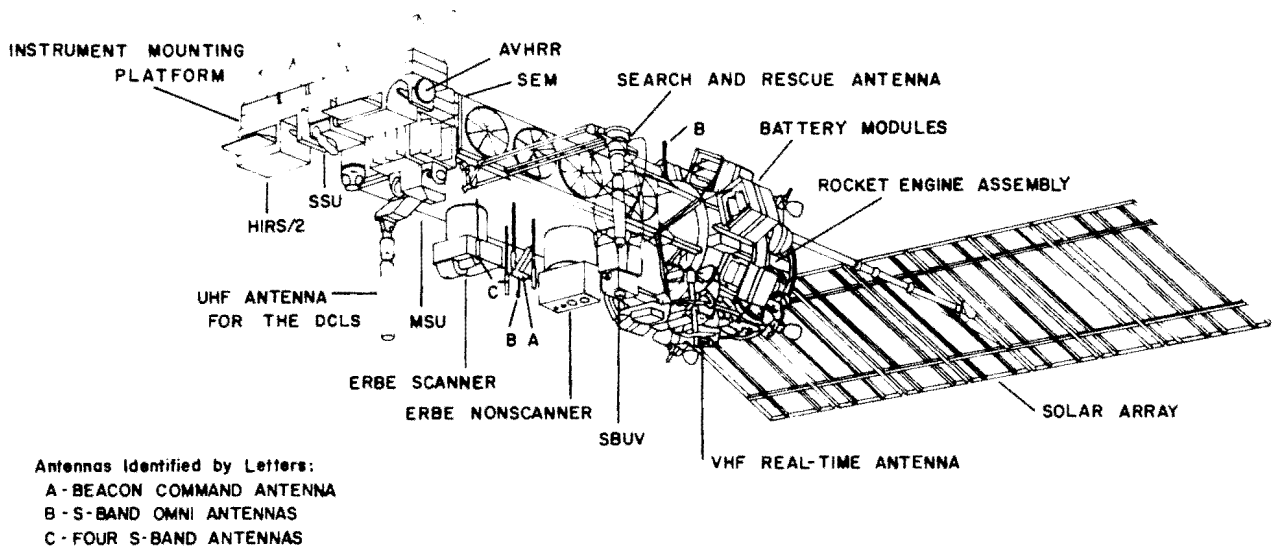

Fig. 5. Diagram of an advanced Tiros-N satellite, showing the various instruments and antennas (from Schwalb 1982). See Table 2 for list of instruments carried by the satellite.

Table 2. *Summary of dimensions, instrumentation, and communication frequencies for Advanced Tiros-N spacecraft.*

Satellite characteristic	Description
Spacecraft	Total weight 2,200 kg
Payload reserved for growth	850 kg
Instrument complement	Advanced Very High Resolution Radiometer (AVHRR) High Resolution Infrared Radiation Sounder (HIRS/2) Stratospheric Sounder Unit (SSU) Microwave Sounder Unit (MSU) Data Collection and Location System-Argos (DCLS) Space Environment Monitor (SEM) Solar Backscatter Ultraviolet Radiometer (SBUV/2) Search and Rescue (SARSAT) Earth Radiation Budget Experiment (ERBE)
Spacecraft size	3.71 m long 1.88 m diameter
Solar array	2.37 m × 4.91 m = 11.6 m ³ 420 watts, end of life, at worst solar angle
Power requirement	Full operation, 330 watts Reserved for growth, 90 watts
Attitude control system	0.2° all axes 0.14° determination
Communications	
Command link	148.56 MHz
Beacon	136.77, 137.77 MHz
S-band ^a	1698, 1702.5, 1707 MHz
APT ^b	137.50, 137.62 MHz
SARSAT	121.5, 243, 406.025, 1544.5 MHz
DCLS (uplink)	401.65 MHz
Data processing	All digital (APT; analog)
Orbit	838, 870 km nominal
Launch vehicle	Atlas E/F
Lifetime	2 years planned

^a See glossary.

^b Analog Picture Transmission.

Additional satellites are being built or procured to take the program into the 1990's. NOAA-H, I, and J have already been procured and will carry instruments similar to those currently aboard NOAA-10 (formerly NOAA-G). Beginning with NOAA-H, a slight orbital change will be made to adjust the local time equatorial crossing of the afternoon satellite from 1430 h to 1340 h local solar time. Procurement is currently under way for NOAA-K, L, and M, scheduled for launch in 1990-92. The Argos-II instruments carried by these satellites will be able to process approximately 4 to 5 times the number of messages processed by the current Argos instruments. The Argos-II package is also scheduled

to be part of the Earth Observing System, which will replace the Tiros-N satellite series after the mid-1990's.

Satellite Orbits

A primary mission of the Tiros-N satellites is to obtain high-contrast imagery and other data for weather forecasting, particularly in the polar regions. High-contrast, low-angle photos (usually best obtained in the hours near sunrise and sunset) provide the best surface feature recognition, making it easier for meteorologists to overlay a map outline on satellite imagery. The near-polar, sun-synchronous

Table 3. *Environmental satellites used for tracking of wildlife.*

Satellite	Letter designation	Launch	Ceased operation	Remarks
Nimbus-3		14 April 69	22 January 72	
Nimbus-4		8 April 70	30 September 80	
Nimbus-5		12 December 72	29 March 83	
Nimbus-6		12 June 75	29 March 83	
Tiros-N		13 October 78	27 February 81	Deactivated
NOAA-6	A	27 June 79	Standby mode	DCLS ^a turned off December 86
NOAA-B	B	30 May 80		Failed to achieve operational orbit
NOAA-7	C	23 June 81	25 February 85	Replaced by NOAA-9
NOAA-D				Never launched
NOAA-8	E	28 March 83	12 June 84	Onboard clock failed 12 June 84 Fully operational 27 June 85 Clock failed again 8 September 85
NOAA-9	F	12 December 84	Operational	
NOAA-10	G	17 September 86	Operational	

^aData Collection System-Argos.

orbit (Fig. 6) of the Tiros-N series allows images of a particular area to be acquired at approximately the same local solar time each day. The two satellite orbits are designed such that a series of passes of 10 min or more by one satellite are made over a given area in the early morning hours, whereas the second satellite makes a series of passes of 10 min or more over the same site in late afternoon. To maintain this sun-synchronous operation, the orbital plane of the satellite must revolve, or precess, about the earth's polar axis in the same direction and at

the same average rate as the earth's annual revolution about the sun.

Nominal orbital parameters for NOAA-9 and NOAA-10 are listed in Table 4. Differences in the approximate altitudes of the two orbits ensure that the same location on earth is not viewed simultaneously by both satellites each day. Because of the earth's rotation during the approximately 102-min period of each orbit, two successive satellite ground tracks are separated at the equator by 25° of longitude, the second ground track being to the west of

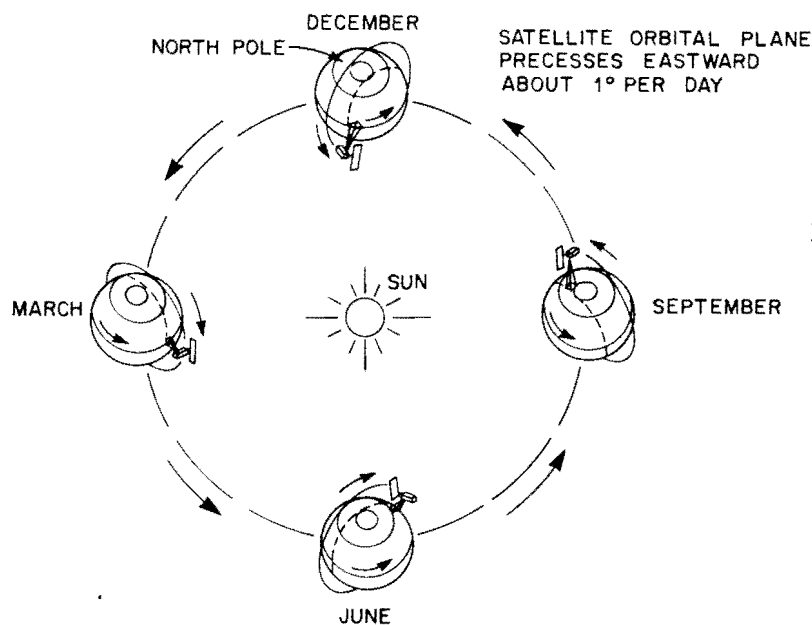

Fig. 6. Tiros-N satellite in a near-polar, sun-synchronous orbit. The dashed lines depict the satellite ground track, which is inclined 97.8° relative to the equator (from Schwalb 1982).

Table 4. *Nominal orbital parameters for NOAA-9 and NOAA-10. Actual values from NASA prediction bulletins^a in early December 1986 are shown in parentheses (adapted from Barnes and Smallwood 1982).*

Parameter	NOAA-9	NOAA-10
Altitude (km)	870	833
Inclination (degrees)	98.90 (99.02)	98.74 (98.74)
Nodal period (minutes)	102.37 (102.08)	101.38 (101.29)
Nodal regression (degrees per degree west)	25.59 (25.52)	25.40 (25.32)
Mean motion (orbits per day)	14.07 (14.12)	14.18 (14.23)

^aElement set numbers 135 (NOAA-9) and 16 (NOAA-10).

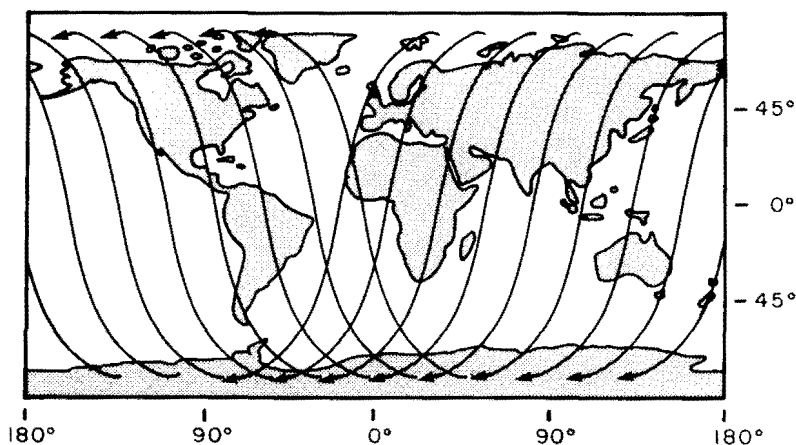

Fig. 7. Mercator projection showing the ground track of a Tiros-N satellite. The ground track at the equator is displaced 25° to the west with each revolution as a result of the earth's rotation during the 102-min period of the satellite.

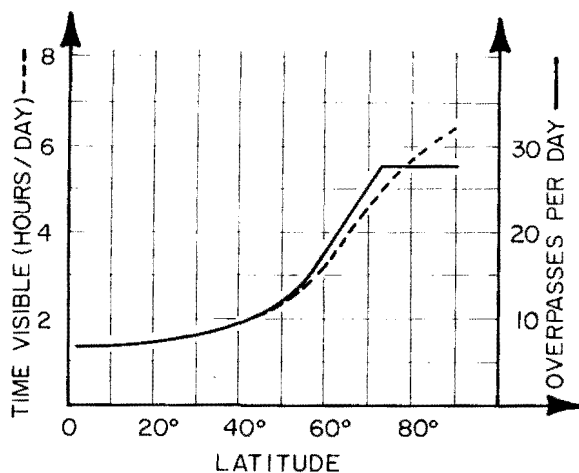

Fig. 8. Relation between latitude of a study area and the degree of coverage by two satellites (from Argos 1984).

the first (Fig. 7). Because the satellite orbits are inclined approximately 98° to the equatorial plane (8° to the polar axis), the ground tracks of two successive passes cross each other at a latitude of 82°, and each satellite can “see” both poles during each orbit. Thus, the number of passes over a given location each day is a function of latitude, ranging from 6 passes/day over a site on the equator to 28 passes/day at latitudes greater than 82° (Fig. 8).

The relation between latitude and the number of passes per day is presented in Figs. 9–10. Figure 9 shows the extent of overlap of areas within view of NOAA-10 on three adjacent passes. The relation between the latitude of a study area and the number of passes per day and the total time a satellite is within view of the study area is shown in Fig. 10. Because the number of orbits per day by each satellite is not an integer, the satellite ground tracks do

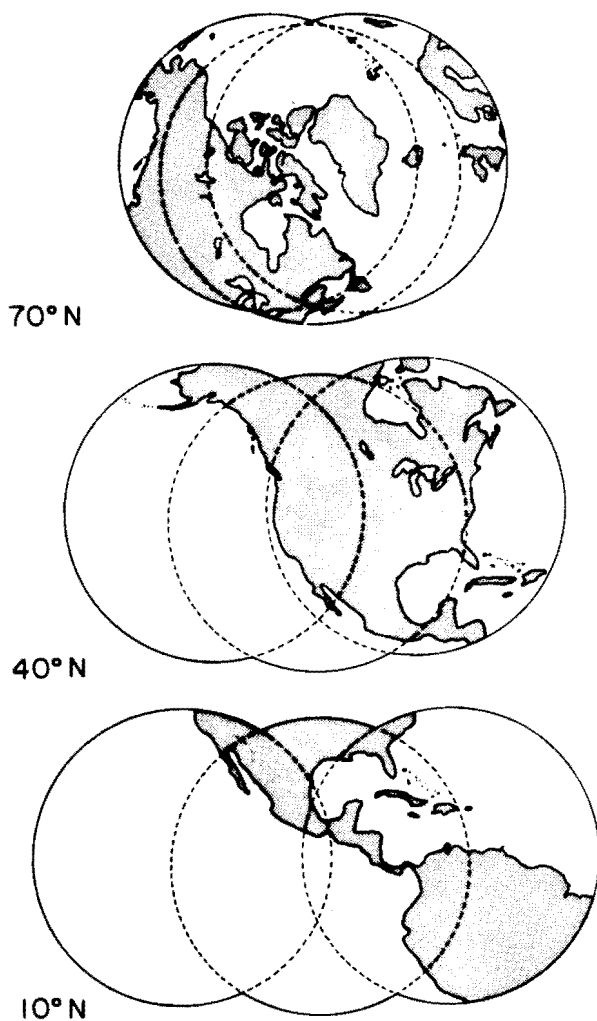

Fig. 9. Areas within view of a satellite on three subsequent overpasses. The increased overlap at higher latitudes results in greater coverage per unit time.

not repeat from day to day, and slight differences occur in the number of passes per day and the cumulative visibility time for a given site (Table 5).

Satellite Overpass Prediction Programs

Satellite overpass predictions for a particular location can be used to determine the optimum duty cycle for transmitters (see *Optimum Duty Cycles*) or to synchronize direct observations of an animal with satellite overpasses to evaluate activity sensors or locational accuracy. Several computer programs are available for predicting overpasses. Telonics, Inc., sells a software package called the Telonics Satellite Predictor that provides the user with a number of options for calculating overpasses. A

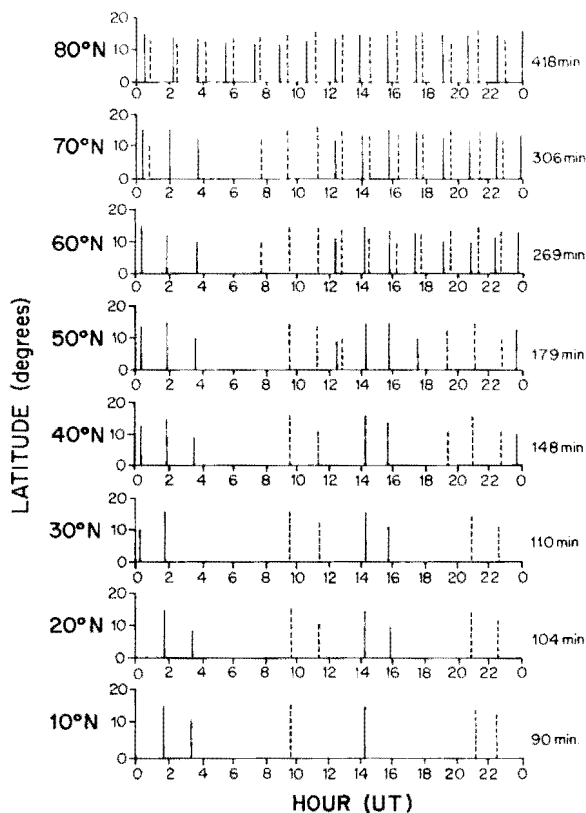

Fig. 10. Daily frequency and duration of overpasses by NOAA-9 (dashed lines) and NOAA-10 (solid lines) at various latitudes. The exact time and duration of each overpass varies, but the general pattern of satellite coverage is similar each day. Numbers on the right give the total time a satellite is above the horizon at each latitude. At higher latitudes a single transmitter may be within view of two satellites simultaneously.

program written by NASA (NORA1) is available through NASA's software dissemination center COSMIC (Computer Software Management and Information Center, University of Georgia, Computer Services Annex, Athens, GA 30602). The NASA program computes satellite look angles (azimuth, elevation, and range) and the subsatellite points (latitude, longitude, height). One of the programs in our software package (TRACK, F77, Appendix A) is a menu-driven modification of the NORA1 program. Service Argos, Inc., provides prediction of satellite overpasses upon request.

Computer programs for predicting overpasses require input of satellite ephemeris data routinely provided by NASA. The ephemeris data provided

Table 5. *Number of overpasses per day and cumulative visibility time as a function of latitude. A satellite is considered to be visible when it is more than 5° above the horizon. The mean duration of a pass is 10 min. At higher latitudes a single platform might be simultaneously viewed by both satellites, but this is not taken into account in this table (from Argos 1978).*

Latitude	Cumulative visibility time over 24 h	Number of passes in 24 hours		
		Minimum	Mean	Maximum
± 0°	80 min	6	7	8
± 15°	88 min	8	8	9
± 30°	100 min	8	9	12
± 45°	128 min	10	11	12
± 55°	170 min	16	16	18
± 65°	246 min	21	22	23
± 75°	322 min	28	28	28
± 90°	384 min	28	28	28

in Part I of the NASA prediction bulletin (Fig. 11) specifies the exact position of the satellite in a Cartesian coordinate system at a particular time. The position and velocity of the satellite before or after those times specified in the prediction bulletin can be calculated from the orbital elements in the prediction bulletin. Part II of the bulletin lists the estimated times when the satellite ground track will cross the equator from south to north on each orbit (i.e., time of the ascending node) and the longitude at which this crossing will occur. An explanation of the various orbital elements is presented in Appendix C. An example of the output from the TRACK program is shown in Fig. 12.

NASA Prediction Bulletins are issued weekly, free of charge, and a user's guide is available. To obtain the relevant bulletins, you must specify the satellite identification number (e.g., NOAA-9 = 15427, NOAA-10 = 16969) in a letter to NASA Goddard Space Flight Center, Code 513.2, Greenbelt, Maryland 20771.

Signal Acquisition and Transfer to Processing Centers

The DCLS equipment aboard each satellite receives signals from the PTT's, demodulates the platform identification number and sensor data, and measures the frequency and time of receipt of each signal. PTT transmissions are received by one of two receiver-search units (Fig. 13) and are then transferred to one of four processing units operating in parallel. The incoming frequency of each signal is

measured and sensor data are formatted, combined with other data generated within the DCLS equipment, and then passed to the Tiros Information Processor (TIP; Fig. 14). The TIP adds synchronization, identification, and time codes before transferring the data simultaneously to the VHF beacon transmitter, onboard tape recorder interface, and the Manipulated Information Rate Processor (MIRP). Output from the TIP and MIRP are stored on tape during each orbit. The DCLS data, which at this point are combined with data from other instruments aboard the satellite, are transmitted to earth either on a real-time basis (via the VHF beacon and high-resolution picture transmission [HRPT]) or are played back from tape on command from one of the Command and Data Acquisition (CDA) stations. Local user terminals (LUT), also known as direct readout stations, use the VHF beacon signal to obtain real-time data from PTT's but can only do so when both the LUT and the PTT are in view of the satellite.

The DCLS data are transferred from CDA stations in Alaska, Virginia, and Lannion, France, to the Argos data processing centers in Landover, Maryland, and Toulouse, France, through a complicated network of ground and satellite communication links (Fig. 15). Data received by the CDA stations are first transferred to a NOAA processing center in Suitland, Maryland, where most of the data collected by the satellites are processed. The DCLS data are stripped from the data stream and transferred through a 9600-baud communications link to the Argos Data Processing Centers. Since April 1987, the processing center in Landover,

NASA PREDICTION BULLETIN

NASA 51004

NASA GODDARD SPACE FLIGHT CENTER, CODE 513 GREENBELT, MD. 20771
 ISSUE DATE: FEBRUARY 23, 1987

BLTN 26 ELEM 26 OBJ 16969 ; IN 3 PARTS PART 1

1 16969U 87 40.60576243 0.00000024 19501-4 0 269
 2 16969 98.7355 72.3994 0012973 213.7022 146.3332 14.22486579 20601

THIS PREDICTION SHOULD NOT BE USED FOR PRECISE SCIENTIFIC ANALYSIS.

PART II S-N EQUATOR CROSSINGS.

REV TIME Z LONG W REV TIME Z LONG W REV TIME Z LONG W

23 FEB 87

2255 743.54 182.56	2256 924.83 207.89	2257 1106.12 233.21
2258 1247.41 258.93	2259 1428.70 283.85	2260 1609.99 309.17
2261 1751.27 334.49	2262 1932.56 359.82	2263 2113.85 25.14
2264 2255.14 50.46		

24 FEB 87

2265 36.43 75.78	2266 217.72 101.10	2267 359.01 126.42
2268 540.29 151.75	2269 721.58 177.07	2270 902.87 202.39
2271 1044.16 227.71	2272 1225.45 253.03	2273 1406.74 278.36
2274 1548.02 303.63	2275 1729.31 329.00	2276 1910.60 354.32
2277 2051.89 19.64	2278 2233.18 44.96	

25 FEB 87

2279 14.47 70.29	2280 155.75 95.61	2281 337.04 120.93
2282 518.33 146.25	2283 659.62 171.57	2284 840.91 196.89
2285 1022.20 222.22	2286 1203.48 247.54	2287 1344.77 272.86
2288 1526.06 298.18	2289 1707.35 323.50	2290 1848.64 348.82
2291 2029.93 14.15	2292 2211.22 39.47	2293 2352.50 64.79

26 FEB 87

2294 133.79 90.11	2295 315.08 115.43	2296 456.37 140.75
2297 637.66 166.08	2298 818.95 191.40	

NASA PREDICTION BULLETIN

BLTN 112 ELEM 112 OBJ 15427 ; IN 3 PARTS PART 1

1 15427U 86234.16815818 0.00000163 10000-3 0 1120

SATELLITE ID#	EPOCH DAY	EPOCH YEAR		FRACTION OF DAY	DECAY RATE.	EPOCH REVOLUTION		ELEMENT SET

2 15427 99.0059 193.0129 0016918 332.7250 27.3027 14.11445081 86964

INCLINATION	RIGHT ASCENSION	ECCENTRICITY	ARGUMENT OF PERIGEE	MEAN ANOMALY	MEAN MOTION	EPOCH REVOLUTION		

Fig. 11. A NASA Prediction Bulletin, which provides satellite ephemeris data for predicting satellite overpasses.

OBSERVATION SITE:							
LATITUDE	64.839						
LONGITUDE	-147.704						
ALTITUDE (M)	250.0						
MIN ELEVATION	.0						
SATELLITE:							
NAME	NOAA9						
ID#	15427						
EPOCH YEAR	86						
EPOCH DAY	357.37187050						
INCLINATION	99.02530000						
PERIOD (MIN)	102.02158607						
TIMES:							
START YEAR	87						
START DAY	30						
START HOUR	.00000000						
END YEAR	87						
END DAY	31						
END HOUR	12.00000000						
INTERVAL (MIN)	1.0						
TIME-OF-DAY WINDOW:	ALL HOURS INCLUDED						
TIMES ARE GMT							
YR	DAY	HR	MN	SC	AZIMUTH	ELEVATION	RANGE (KM)
87	30	0	30	0	182.6	3.5	3086.7
87	30	0	31	0	185.3	7.6	2710.7
87	30	0	32	0	188.8	12.5	2344.1
87	30	0	33	0	193.7	18.3	1994.1
87	30	0	34	0	201.1	25.5	1672.7
87	30	0	35	0	213.0	34.2	1401.2
87	30	0	36	0	233.4	42.8	1214.9
87	30	0	37	0	263.7	46.4	1156.4
87	30	0	38	0	292.5	41.4	1244.0
87	30	0	39	0	310.8	32.5	1451.2
87	30	0	40	0	321.6	24.1	1734.9
87	30	0	41	0	328.4	17.3	2062.9
87	30	0	42	0	333.0	11.7	2416.3
87	30	0	43	0	336.4	7.0	2784.2
87	30	0	44	0	339.0	3.0	3160.4

Fig. 12. Satellite look angles for an overpass by NOAA-9, as generated by the TRACK program described in Appendix A.

Maryland, has operated in parallel with the Toulouse Center to serve North American users. In the event of a total failure at one of the two processing centers, the other center will take over all PTT processing.

Messages from PTT's within the satellite's field of view (a circle with an approximate diameter of 6,000 km) reach the Argos receiver in a random fashion. The onboard instruments can handle four messages simultaneously, provided they are separated in frequency. Frequency separation is achieved by the Doppler shift in the carrier frequency of each PTT as the satellite passes overhead. Messages are also separated in time by asynchronous transmission times and different repetition periods. The probability that the satellite will receive

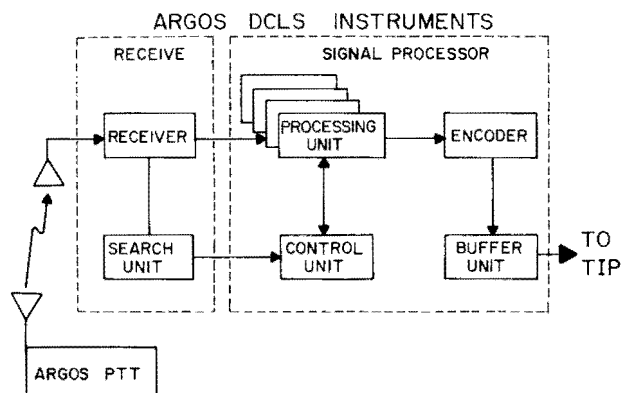

Fig. 13. Schematic of instruments onboard the satellites that receive and process messages from Argos-compatible transmitters (adapted from Argos 1984).

at least one transmission from a particular PTT can be computed by the formula $p = 1 - (1 - P_e)^N$ where P_e is the elementary probability when all four processing units are operational, and N is the number of messages transmitted by the PTT while the satellite is in view. P_e is in turn a function of the number of messages from all PTT's received by the Argos instruments in 1 sec (Fig. 16). This relation is based on simulation studies assuming that all PTT's transmit 4 bytes of sensor data such that all messages have a duration of 360 ms. The probability that all N messages will be received is calculated simply as $(P_e)^N$ (Argos 1978).

The capacity of the Argos system thus depends on numerous factors, including the spatial distribution of PTT's, duty cycles, repetition period, and message duration. Argos has estimated a 99% probability of locating 4,000 locational PTT's during a 24-h period, or 346 within view of a satellite simultaneously. The system capacity for data-collection PTT's is 16,000 with a 99% probability of data collection during a 12-h period (Argos 1978), or 1,152 within view of a satellite for a platform having a repetition rate of 200 sec and transmitting 4 bytes of sensor data.

Location Determination

Calculations for determining locations of PTT's are conducted at the Argos Data Processing Centers in Toulouse, France, and Landover, Maryland, following each satellite pass. The location of a PTT is determined from the Doppler shift in the carrier frequency transmitted by the PTT. The Doppler effect is the perceived change in frequency resulting

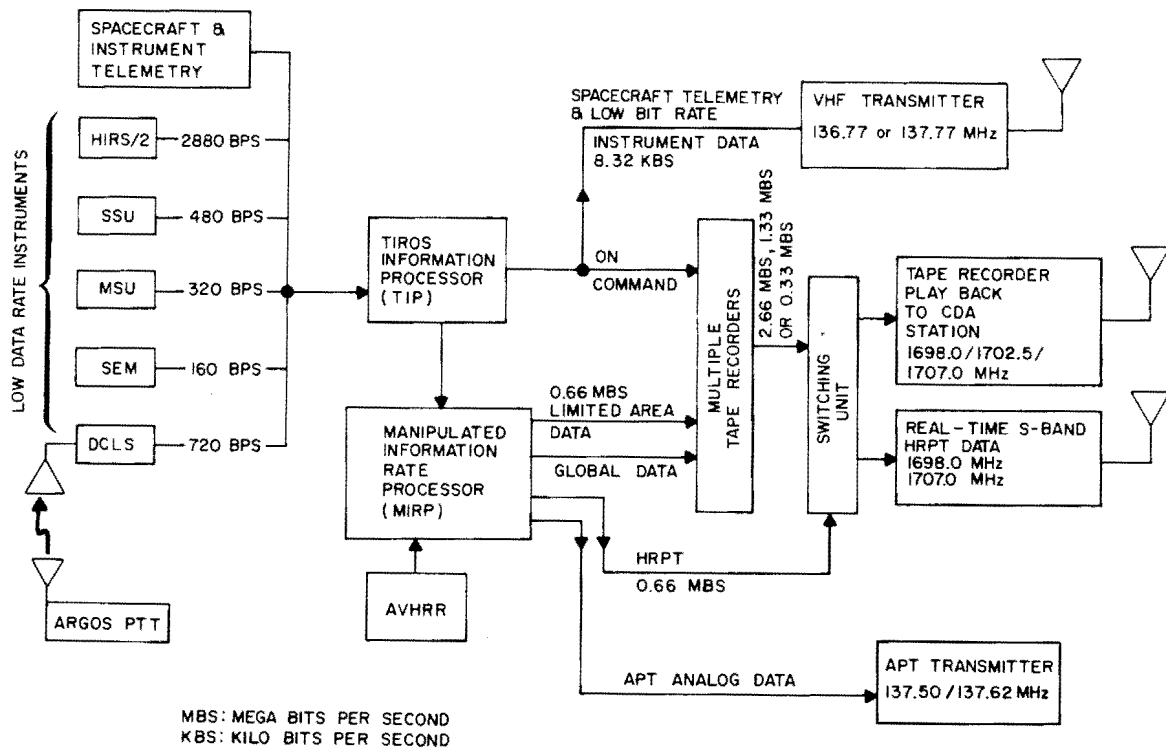

Fig. 14. Data transfer and processing channels onboard each Tiros-N satellite. Messages from animal transmitters are passed from the Argos instruments to the Tiros Information Processor, recorded on tape, and transmitted in either real-time or via tape playback to Command and Data Acquisition stations (adapted from Schwab 1982).

from the relative movement of the source and receiver. As the satellite approaches the PTT, the frequency received by the instruments on board the satellite will be higher than the transmitted frequency (401.650 MHz), whereas frequencies lower than 401.650 MHz will be received by the satellite as it moves away from the PTT (Fig. 17). At the point of inflection of the Doppler curve, that is, when the received and transmitted frequencies are equal, the position of the transmitter will be perpendicular to the satellite ground track.

A field of possible positions for the PTT under consideration is calculated for each message received by the satellite. This field is in the form of a half-cone (Fig. 18), with the satellite at its apex, the satellite velocity vector as its axis of symmetry, and an apex half angle determined by the equation $\cos A = (C \div V) (F_R \div F_0)$ where C is the speed of light (the propagation speed), V is the satellite velocity, F_R is the carrier frequency received by the satellite, and F_0 is the transmitted frequency (401.650 MHz). The satellite velocity is determined from orbital characteristics, as explained below. One locational half-cone is obtained for each Doppler

measurement. The intersection of two or more of these cones with the altitude sphere, which in the case of a terrestrial mammal is assumed to be sea level, yields two possible positions for the PTT that are symmetrical with respect to the satellite ground track (Argentiero and Marini 1979; see lower portion of Fig. 18). The second, erroneous position is called the image. The actual position of the platform is determined from previous locations, the platform velocity, and the earth's rotation. For slow-moving PTT's (i.e., less than 20 m/sec), the ambiguity can be resolved in 95% of the cases (Argos 1978). The calculations involve an iterative least-squares technique that produces the position that minimizes differences between the expected and measured Doppler history (Levanon 1984). Before April 1987, Argos provided users with both the primary location of the transmitter and its image. Data provided by the new data-processing centers that became operational on 1 April 1987 contain only the primary location for the PTT, which in some cases might be incorrect. Argos has agreed to again provide both the calculated location and its image, beginning in October 1987.

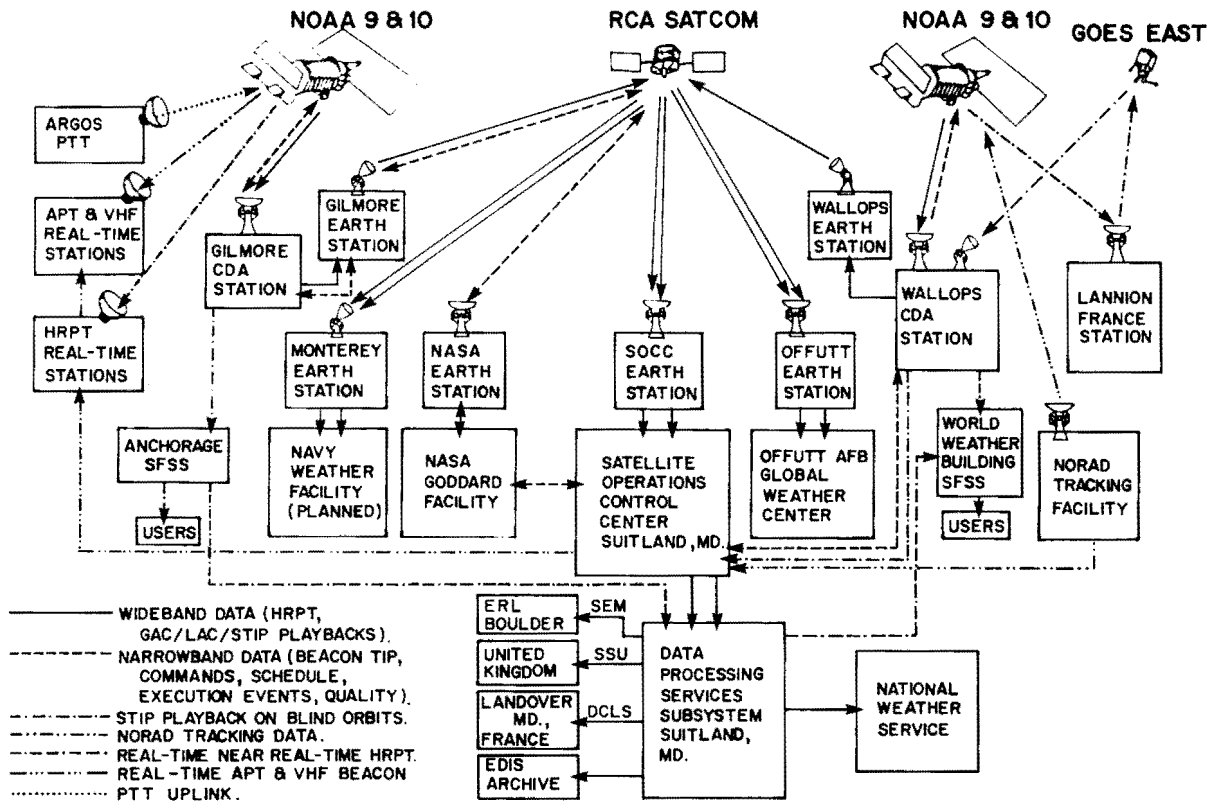

Fig. 15. Communication links used to receive, transmit, and transfer data from Argos and other instruments on-board the satellite.

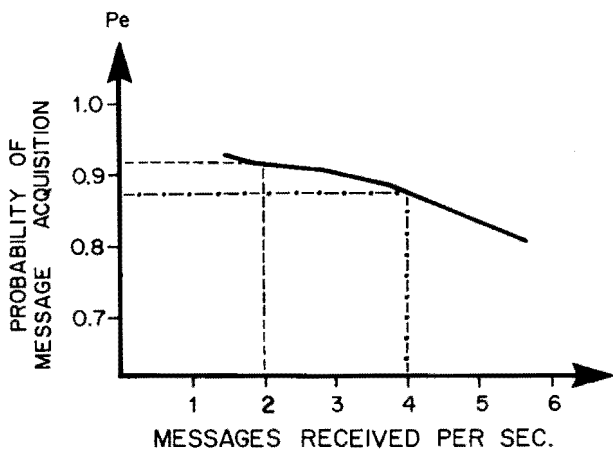

Fig. 16. Relation between the probability of a message being received by the Argos instruments and the number of messages having the same frequency received per second. Data are from simulation studies and assume that all four processing units within the Argos instrument package are functional (adapted from Argos 1978).

Other information used in the location calculations includes satellite orbital elements and precise timing of measurements. Orbital elements for each satellite are provided regularly by the Air Force Space Command tracking facility in Colorado. Argos also maintains 11 reference PTT's that transmit at 30-sec intervals from precisely known locations around the world. Data from these reference platforms are used to correct the satellite orbital predictions and make it possible to predict the satellite position to within 300 m along the ground track and 250 m in the across-track direction (Argos 1984). A high-precision time-coding platform based on a cesium clock transmits from Toulouse, France. This time-coding information is used to monitor the stability of the onboard oscillator and to synchronize all measurements within a mean precision of 12 ms (Argos 1984).

To calculate a location from a single overpass, Argos normally requires a minimum of five Doppler measurements for a particular PTT, with at least a 420-sec interval between the first and last measurements. If the user wants more locations, Argos will

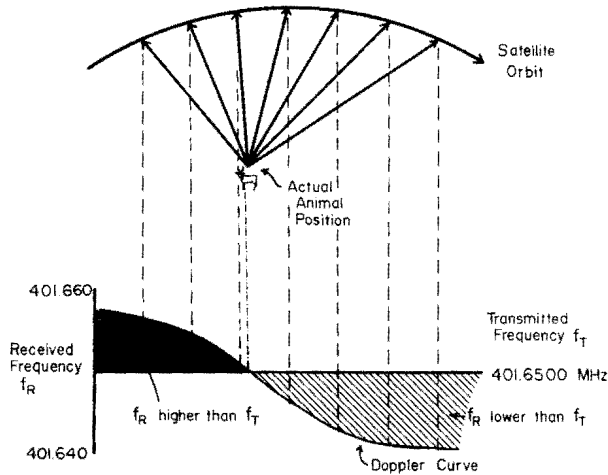

Fig. 17. Doppler shift in the uplink carrier frequency as the satellite approaches and then moves away from the location of a radio-collared animal. The slope of the Doppler curve at the inflection point determines the distance from the animal to the satellite ground track.

calculate less-accurate locations from only four Doppler measurements separated by 240 sec. In each case, the algorithm uses least-square analysis to calculate PTT latitude, longitude, and the exact transmit frequency. The platform velocity is assumed to be zero in the calculations. The ambiguity between the actual location and its image is resolved primarily by the previous location of the PTT.

Before April 1987, Doppler measurements for a particular PTT made during two subsequent over-passes by the same satellite or during one pass by each of the two satellites were sometimes combined to increase the accuracy of the calculated location (Fig. 19). The two-pass algorithm requires at least 12 Doppler measurements, with at least 5 measurements from each pass, and yields latitudinal and longitudinal velocity components in addition to a more accurate position (Rosso 1985).

Several quality control criteria are used by Service Argos to prevent calculating locations with unacceptable accuracy. The primary basis for rejection is distance of the PTT from the satellite ground track (Rosso 1985; Fig. 20). Service Argos has found that locational errors are highest when the PTT is within approximately 170 km of the ground track or more than 2,700 km from it (Argos 1984). If the mean transmission frequency for a PTT during two passes differs by more than 24 Hz, or the short-term

frequency stability exceeds 4×10^{-5} , no location is calculated (Argos 1984).

The altitude of the PTT and the short- and mid-term stability of the PTT's oscillator influence locational accuracy. Errors resulting from differences in the altitude of the PTT and the assumed altitude (usually sea level) are coupled to the across-track coordinate of the fix and have essentially no effect on the along-track coordinate. Because the satellite orbits are nearly polar (only 8° inclination from the polar axis), the across-track error is almost equivalent to an error in longitude (Levanon 1984). Studies have shown that these locational errors only assume major significance for high-flying balloons and birds, and the degree of error depends on the maximum elevation of the satellite during the pass. For example, French (1986) showed that for a maximum

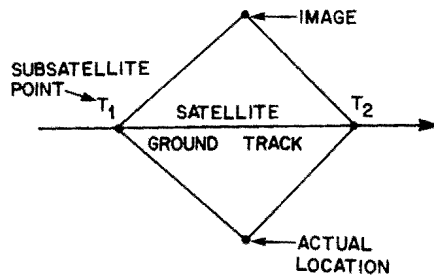
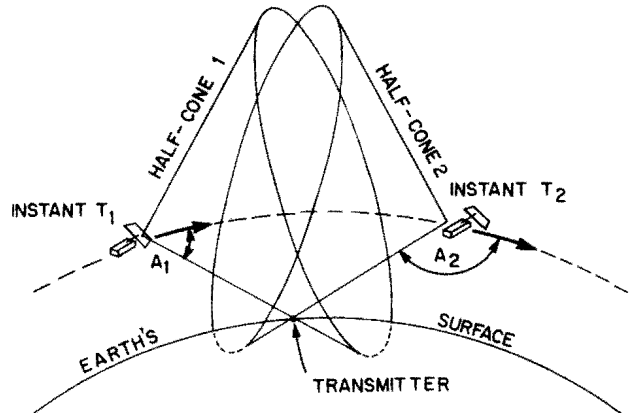

Fig. 18. Summary of the procedure used to calculate animal locations. Each half-cone results from a single message and intersects the earth at two points, equidistant from the satellite ground track. An iterative least-squares procedure is used to calculate the actual location of the animal and its alternate location or image (adapted from Argos 1984).

LOCATION

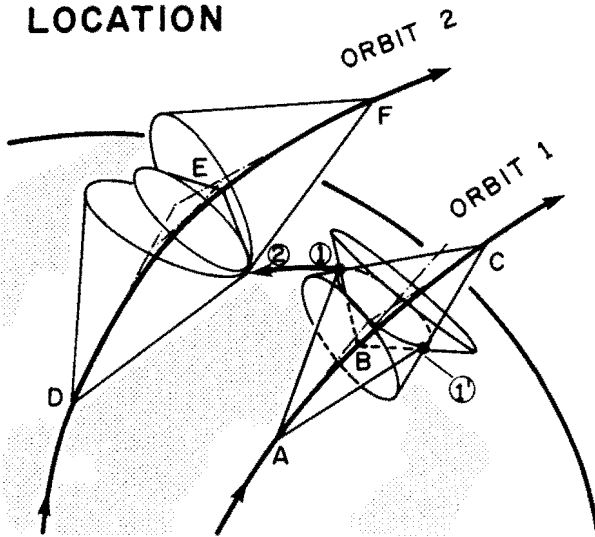

Fig. 19. Example of how Doppler data from two overpasses are merged to provide a more accurate location. Data received during orbit 1 were used to calculate locations at point 1 or 1'. Data acquired during orbit 2 were used to verify point 1 as the true location and to calculate a movement vector between points 1 and 2. Letters represent the position of the satellite when Doppler measurements were made (adapted from Argos 1978).

satellite elevation of approximately 26° , an altitudinal error of 500 m results in a range error of 250 m (Table 6).

An important source of error for most animal PTT's is oscillator stability, which is largely influenced by temperature (Argos 1984). Argos certification requires a medium-term stability of 4 Hz over 20 min, or one part in 10^{-8} Hz; an oscillator stability of this magnitude should result in locational errors of less than 1,100 m in 65% of cases, according to Service Argos data (Argos 1984). Experimental data from well-insulated PTT's with a medium-term stability of 10^{-8} Hz resulted in a root mean square (RMS) error of 320 m for locations based on a single satellite overpass (Fig. 21) and 235 m for locations calculated from messages received during two overpasses. (The RMS error is equivalent to 1 standard deviation of the distances from a mean of zero.) Data showing the effect of PTT distance from the satellite ground track were presented for the same experiment (Rosso 1985; Fig. 22). The locational accuracy of the smaller Telonics PTT's used on animals, which are subjected to greater temperature extremes than those used by Rosso (1985), is presented later in this report.

Applications to Wildlife Research and Management

Transmitter Manufacturers, Specifications, and Costs

At the time of writing (March 1987), we know of only two commercial manufacturers in North America that produce Argos-certified PTT's that have been used with animals. PTT's manufactured by these two companies, Wood-Ivey Systems Corporation (WISCO) and Telonics, Inc., are described below. The Applied Physics Laboratory (APL) of

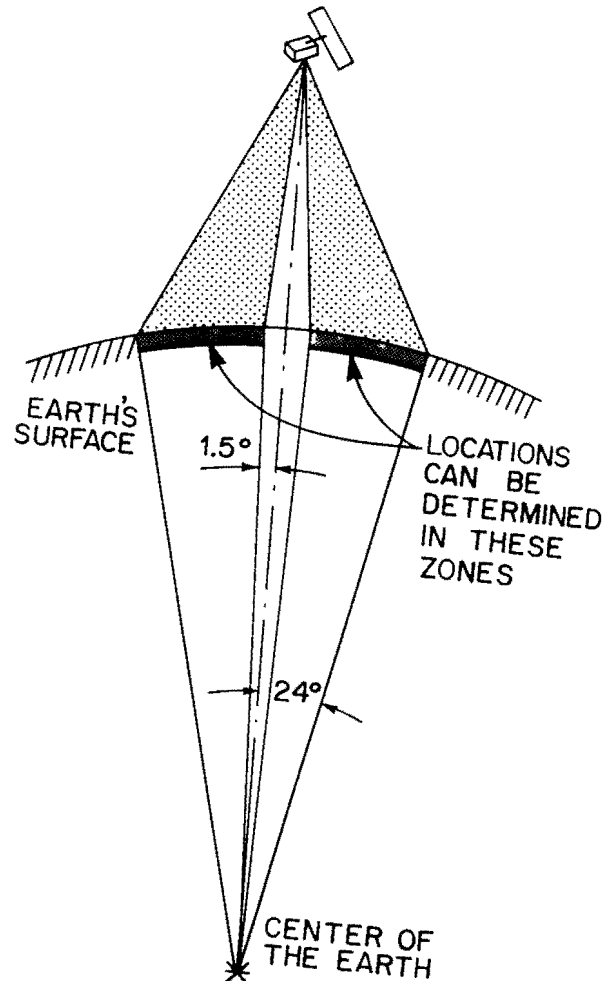

Fig. 20. Locations can be calculated for transmitters within a zone of approximately 170-2,700 km on either side of the satellite ground track. Locational errors are usually unacceptably high if the transmitter is outside these zones (adapted from Argos 1984).

Table 6. Effect of maximum satellite elevation during a pass and the difference between the assumed and actual PTT^a altitude on locational accuracy (French 1986, Fig. 5).

Maximum elevation (degrees)	Altitudinal error (m)	Locational error (m)
20	500	125
	1,000	400
	2,000	575
40	500	575
	1,000	800
	2,000	1,200
60	500	950
	1,000	1,600
	2,000	3,000

^aPlatform transmitter terminals.

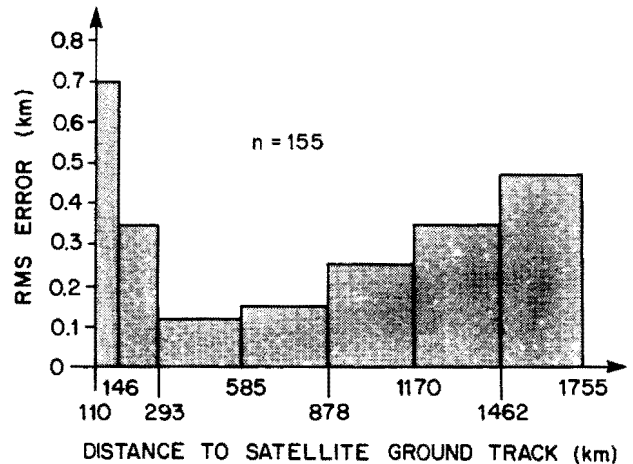

Fig. 22. Relation between locational errors and distance from the transmitter to the satellite ground track (modified from Rosso 1985).

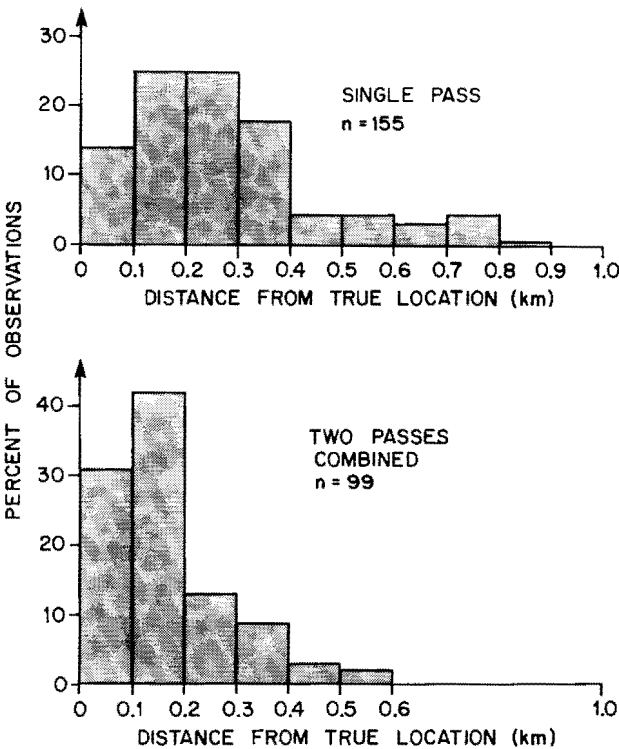

Fig. 21. Locational errors reported by Rosso (1985) for a relatively large, well-insulated, Argos-compatible transmitter.

Johns Hopkins University has developed solar-powered PTT's for use on birds (Strikwerda et al. 1986), but these PTT's are not commercially available. Licenses for manufacturing the solar-powered PTT developed at APL were granted to Polar Research Laboratory, Inc., and WISCO, but both companies have decided not to manufacture additional units because of high production costs and difficulties with duplicating transmitter design (H. Ivey, WISCO, and J. Anderson, Polar Research Laboratory, personal communication). Other companies in Europe and Japan produce PTT's for animal tracking, and some of the larger PTT's built by American and Canadian companies might be suitable for certain animal research applications. A list of companies producing Argos-compatible equipment with potential applications for wildlife research is presented in Table 7.

WISCO's model 165 PTT (Fig. 23) has been enclosed within a waterproof housing and used by the National Marine Fisheries Service to track marine turtles. The PTT must be combined with an external power supply, antenna, sensors, data conditioners, and some type of housing designed specifically for the desired application. The resulting package is too large and heavy for use with most terrestrial animals but might have applications with marine species or as a fixed-location transmitter. The 1987 price for 1-3 units is \$1,675 each, not including the power supply, antenna, sensors, and environmental enclosure.

Table 7. *Manufacturers of Argos-compatible equipment with applications for wildlife research. Adopted from Service Argos Directory of Argos-compatible Equipment and Manufacturers.*

Company	Contact	Products
North America		
Microlog Corporation 18713 Mooney Dr. Gaithersburg, MD 20879 (301) 258-8400	Bob Brown	Local User Terminal
Polar Research Laboratory 6309 Carpinteria Ave. Carpinteria, CA 93013 (805) 684-0441	John Anderson	Local User Terminal, Uplink Receivers
Telonics, Inc. 932 E. Impala Ave. Mesa, AZ 85204 (602) 892-4444	Stan Tomkiewicz Jeannie Russell	Whale PTT's ^a , Terrestrial Animal PTT's, Local User Terminal, Uplink Receiver
Wood-Ivey Systems Corp. (WISCO) P.O. Box 4609 Winter Park, FL 32793	Gordon Smith	Animal PTT, Local User Terminal
Overseas		
Marinar Radar Ltd. Bridleway, Camps Heath Lowestoft, Suffolk Great Britain NR32 5DN Tel: 0502-67195	Dr. J. French	Bird-borne PTT's, Animal PTT's, Uplink Receivers
Toyo Communication Equip. Corp. 753 Koyato, Samukawa-Machi Kopza-Gun, Kanagawa-Pref Code 253-01 Japan Tel: 0467-74-1131	J. Tsutsumi	Animal PTT's, Local User Terminal

^aPlatform transmitter terminals.

All of the PTT's we have tested since 1984 were manufactured by Telonics, Inc. In addition to the SAT 103 subsystem described below, Telonics has also developed a PTT for attachment to whales (Mate et al. 1983; Mate 1984; Mate unpublished data). The first Telonics PTT's tested on terrestrial animals were deployed on caribou (Pank et al. 1985; Craighead 1986; Curatolo 1986) and muskoxen (Reynolds 1986) in 1984. These first-generation PTT's (Table 8) were replaced by smaller, lighter, and more accurate second-generation PTT's during April 1985. Additional improvements resulted in the third-generation PTT's currently being produced by

Telonics (Fig. 24). Except where specified, the following discussion refers to the third-generation Model CM 10001-004 PTT.

All PTT components, except the antenna and VHF beacon, are enclosed within a welded, hermetically sealed canister capable of prolonged immersion in water. The canister is attached to an adjustable collar 5-10 cm wide that remains pliable to -40°C. The UHF antenna is approximately 15 cm long and is either sewn within the collar (polar bear configuration) or protrudes approximately 4 cm from the collar (caribou configuration). The antenna does not protrude from the polar bear configuration because

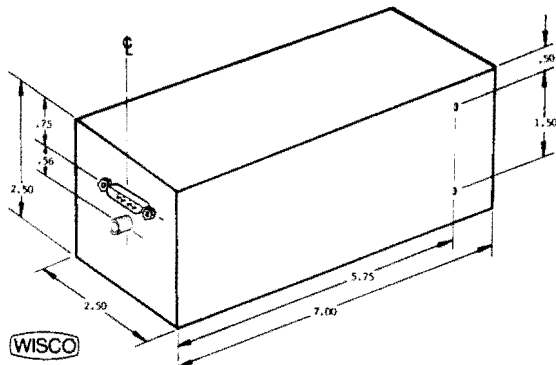

WISCO Model 165 Argos Platform Transmitter Terminal

Case Material : Aluminum
 Case Finish : Gold Iridite
 Weight : 1.50 lb (0.68 Kg)
 Mounting Holes : Threaded 6-32, same pattern on opposite side. Four 6-32 screws 3/8" long secure case to internal assembly. These screws can also be used for mounting.
 Input Connector : 9-pin male D connector
 Output Connector : SMA female coaxial connector

Connector Pin Assignments :

1	○	5	1. Spare
○	○	○	2. +8V Osc.-on, output
○	○	○	3. +12V (nominal) power input
6	○	9	4. Spare
View	○	○	5. Ground, power supply return *
from outside	○	○	6. Test reset, input
			7. Data clock, output
			8. Data enable, output
			9. Serial data input

*Case also ground

Dimensions and Connector Data

WOOD-IVEY SYSTEMS CORPORATION

Fig. 23. Dimensions (in inches) and description of a Model 165 PTT (platform transmitter terminal) built by Wood-Ivey Systems Corporation and used for tracking sea turtles.

ice may form on the antenna tip, breaking it. However, some loss of signal strength and data can occur when the tip of the antenna does not protrude from the collar. The PTT is powered by three D-size lithium batteries having a life of approximately 3 months if run continuously (1 transmission/min, 4 sensor bytes), or 1 year if cycled 6 h on-18 h off (see *Optimum Duty Cycles*). Our units include sensors to measure internal PTT temperature and short-term and long-term indices of animal activity (see Sensor Development and Calibration). A VHF beacon is attached to all collars for locating collared animals from aircraft and to serve as a backup in case of PTT failure.

The 1988 cost of the Telonics PTT (excluding VHF beacon) is \$3,500 for 1-3 units, \$3,250 for 4-9 units, or \$3,000 for 10-50 units. Used PTT's can be refurbished for approximately \$500-\$650. Three months are normally required for delivery of new PTT's, whereas 6 weeks are required for delivery of refurbished collars.

Optimum Duty Cycles

The primary determinant of satellite transmitter weight, except for models using solar cells, is the weight of the primary batteries. The relatively high power output of the satellite transmitter (e.g., peak effective radiated power over 2,000 times that of a conventional VHF transmitter) and the need for a lightweight package that can be carried by an animal produces a conflict between life of the transmitter and the number of messages that can be sent. A Telonics third-generation PTT transmitting once per minute, for example, will operate for approximately

Table 8. Specification of Argos-certified transmitters built by Telonics, Inc., for terrestrial mammals.

Specification	Transmitter generation		
	First	Second	Third
Canister dimensions	8.45 cm × 11.20 cm × 7.18 cm	6.86 cm × 10.80 cm × 5.89 cm	7.00 cm × 11.43 cm × 5.72 cm
Canister weight	1,400 g	800 g	880 g
Total weight including collar and VHF ^a beacon	2.2 kg	1.6 kg	1.6 kg
Operating range	-20°C to +61°C	-40°C to +70°C	-40°C to +70°C
Weight of electronics circuitry	150 g	100 g	60 g

^aVery high frequency.



Fig. 24. Third-generation transmitter built by Telonics, Inc. This particular platform transmitter terminal (PTT) is configured for a polar bear and weighs 2 kg.

3 months, but if the PTT is programmed to transmit during only a 6-h window every 4 days, the theoretical battery life increases to 24 months. In the latter case, fewer locations and sensor data will be obtained each day, but the extended lifetime of the PTT might be more important in some studies.

The optimum duty cycle is determined by study objectives and by the timing and quality of satellite passes over the study area. Duty cycles must be specified when the transmitters are ordered because the duty cycle is programmed in components that are sealed inside the canister. However, the starting of the transmitter is controlled with a magnetic switch. For example, the duty cycle of a transmitter can be programmed as 6 h on–18 h off, but the start of the 6-h-on period depends upon when the magnet is removed from the outside of the canister.

One of the first steps in deciding on a duty cycle is to generate overpass predictions for the study area using the program TRACK (Appendix A) or one of the other pass-prediction programs (see *Satellite Orbits*). Figure 25 shows how the timing and quality of overpasses varies between different study areas. A researcher in Maine, for example, would be wasting battery life if the PTT transmitted between midnight and 0600 UT (Universal Time) or 1300 and 1600 UT, whereas a gap in satellite coverage in Colorado occurs between 0400 and 0800 UT.

All of the overpass prediction programs require a set of orbital elements (i.e., satellite ephemeris data) as a starting point in their calculations. Although pass predictions become less accurate as the difference in time increases between the date of the initial orbital element set and the predicted

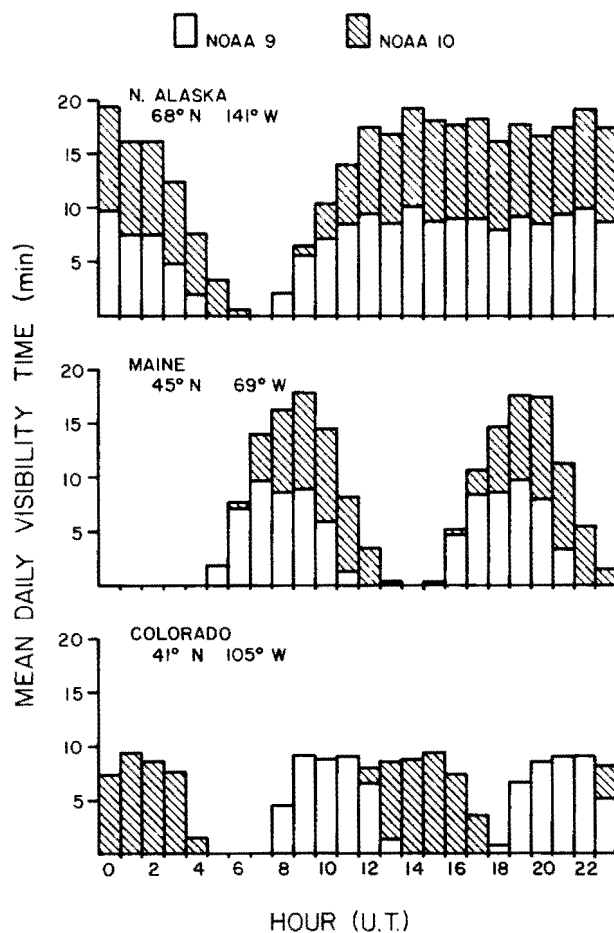

Fig. 25. Overpass predictions for three study sites, based on output from the TRACK program (Appendix A) for a 1-month period.

set, it is still possible to generate reliable frequency distributions of overpasses for each hour of the day for the purpose of determining the optimum duty cycle. We verified this with the TRACK program by comparing predicted satellite rise times, generated with recent data, with predictions for the same passes based on 6-month-old ephemeris data. In this particular example, an error of only 3 min was introduced by making predictions 6 months into the future.

The minimum number of hours that the transmitter must be on to ensure a locational fix depends on the satellite overpasses and on characteristics of the study animal and its habitat. Caribou transmitters, for example, operated on a cycle of 6 h on–18 h off cycle, and resulted in sensor data being acquired during 5.5 ± 2.1 SD overpasses/day for each caribou; a mean of 3.1 ± 5.0 SD locations/day were calculated. About 24 passes/day occurred over our study areas. We used a duty cycle of 12 h on–60 h off for polar bear transmitters. Although the polar bear PTT's transmitted twice as many hours per active day as those on caribou, sensor data were received during only 5.9 ± 3.8 SD overpasses/active transmitter-day and obtained a mean of 1.7 ± 6.9 SD locations/day. The poorer performance of the polar bear units is thought to be related to submersion of PTT's in water during overpasses, the proximity of antennas to the bear's wet fur (VSWR effect; see Appendix D), marginal signal strengths resulting from encased antennas within the collars or transmission through snow den walls for some bears, and very low (below -40°C) ambient temperatures. Caribou PTT's provided a location for 54% of the overpasses when sensor data were received. Based on our experience, we expect a location from PTT's on terrestrial species such as deer, moose, elk, or sheep for half of the satellite overpasses having a maximum elevation of 15° or more over the study area.

Sensor Development and Calibration

The modulated portion of the transmitted message can contain 32 to 256 bits of sensor data, in blocks of 32 bits. The sensor data for large PTT's on buoys or at fixed sites can include variables such as ambient temperature, wind speed, wind direction, relative humidity, and sea surface temperature. Sensors shorten battery life, add weight to the PTT, and increase PTT cost. However, sensors allow remote

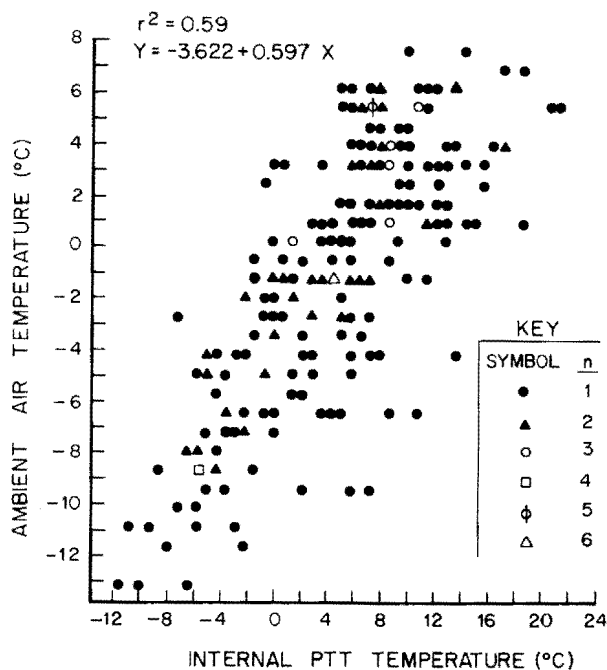

Fig. 26. Relation between ambient temperature and the internal temperature of the platform transmitter terminal (PTT) canister (adapted from Pank et al. 1985).

sensing of the animal's environment and its behavior and physiology.

The standard Telonics PTT's transmit the minimum 32 bits of sensor data. Each message includes measures of the internal temperature of the PTT, a short-term (previous minute) index of the animal's activity, and a long-term (previous day) index of activity, that also serves as a mortality indicator. The internal PTT temperature is correlated with ambient temperature (Fig. 26), but rapid changes in ambient temperature might not be reflected in the sensor's output because of the insulating properties of the canister and internal PTT components.

Temperature Sensor

The temperature sensor outputs a count between 0 and 50,000 that is related to temperature ($^{\circ}\text{C}$) through a third-order polynomial equation. The equation for each temperature sensor can be calculated with the program EDITPTT (Appendix A) using data for each PTT provided by Telonics, Inc. Because the largest number that can be held in 8 bits is 255, the count is transmitted as 2 data bytes (16 bits). The temperature count is calculated by multiplying the contents of the first byte by 256 and

adding the contents of the second byte. For example, if the first 2 bytes of sensor data received by a satellite were reported as 048 096, the temperature count would be calculated as $(48 \times 256) + 96 = 12,384$. This count would then be converted to °C using the third-order polynomial regression developed for the particular sensor.

Activity Sensors

The third and fourth bytes of sensor data contain the two measures of animal activity. The short-term index is a count between 0 and 60, representing the number of 1-sec intervals each minute during which a specially configured mercury switch within the PTT is activated. Using captive caribou, we found that counts of 0–5 usually indicated that the animal was lying, whereas a count of 55–60 usually indicated that the caribou was running (Fig. 27). The system includes two registers of activity counts. During each 60-sec interval, the contents of the first register will be increased by 1 during each second that the mercury switch is activated. At the end of the 60-sec interval, the contents of this first register are transferred to the second register. The number stored in the second register is the count that is transmitted every 40–60 sec (depending on the PTT's repetition rate) when the PTT is active.

The long-term activity index, which also serves as a mortality indicator, is the sum of the 60-sec counts over a 24-h period. When the PTT is first activated by removing the magnet from the canister, a third register begins to accumulate the short-term index counts for 24 h. At the beginning of the second 24-h interval, the contents of this third register are transferred to a fourth register, and the number stored in the fourth register is incorporated into the transmitted message.

The temperature count uses 16 bits of the uplink message, leaving 16 bits for the two activity counts. The short-term index (0–60) requires 6 bits, leaving 10 bits for the long-term activity index. There are 86,400 sec in a day, but because the largest number that can be transmitted in 10 bits is 1,023, the index is coded by dividing it by 85. Consequently, each long-term activity count must be multiplied by 85 to restore the original value.

Activity Switch Calibration

The configuration of the mercury switch within the PTT canister and the counting intervals (e.g., 60 sec, 24 h) have a major effect on the utility of the

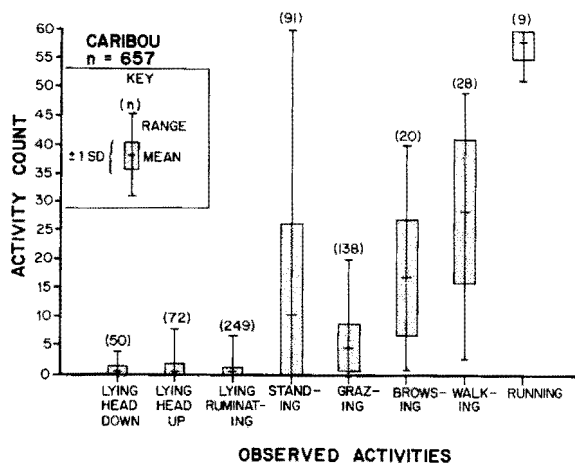

Fig. 27. Relation between the short-term activity index and several activity categories for caribou. The mercury switch was oriented parallel to the caribou's spine and angled +2° relative to the circuit board. Sample sizes represent the number of minutes for which the caribou exhibited only one activity during the 1-min interval.

activity indices. A microprocessor in the Telonics first-generation PTT's deployed in 1984 incremented a register if the mercury switch was closed during the previous minute (rather than the previous second). The transmitted indices represented the sum of these counts for the previous 30-min or 6-h period. Research using captive caribou showed that these activity counts were not correlated with animal behavior (Pank et al. 1985). Much better results have been obtained using the current counting intervals, but the optimal mercury switch orientation within the collar will differ for different species. Based on the work of Pank et al. (1985) using captive caribou, PTT's used with caribou have the switch oriented parallel to the caribou's spine and angled +2° relative to the circuit board. This orientation allowed some differentiation among several activity categories (Fig. 28), but the same angle on other species gave poor results. We are continuing research with captive animals using a specially configured PTT and an uplink receiver to determine the best switch orientation for several species of large mammals, including caribou, muskoxen, Dall sheep, mule deer, elk, polar bears, and gray wolves. We are also refining our calibration of the short-term index with caribou and investigating the potential to estimate activity budgets from the index.

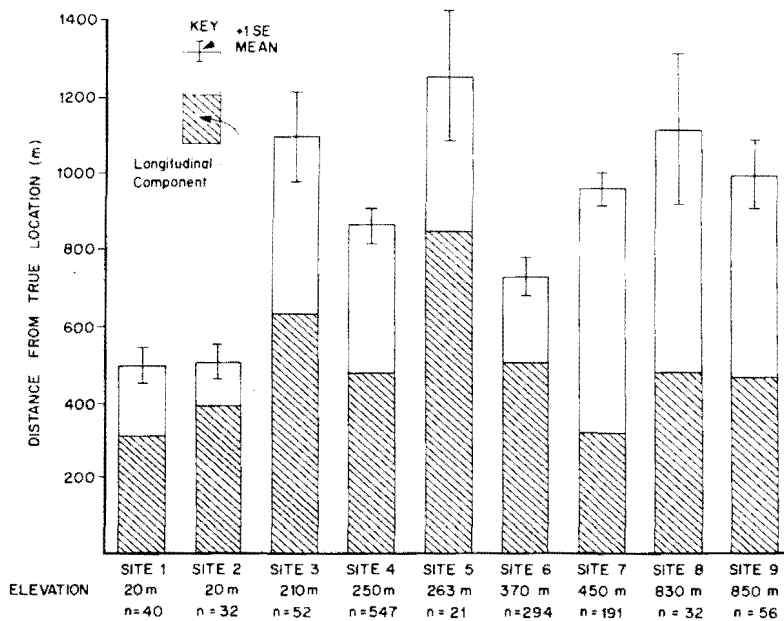

Fig. 28. Locational errors for nine sites (Table 9). The effect of site elevation, which theoretically influences the longitudinal component of locational errors, is not evident in this data set because of the masking effect of other sources of error.

Other Sensors

In addition to the temperature and activity sensors, we are currently testing sensors to determine the amount of time polar bears and walrus spend in the water (i.e., a saltwater switch) and a pressure sensor for measuring dive depths. Similar sensors have previously been used in studies of whales (Mate et al. 1983, unpublished data). Saltwater switches can also be used with diving animals to prolong battery life by preventing transmission when the PTT is underwater. The polar bear PTT's with a saltwater switch record the amount of time the bear spends in the water over a 72-h period and the number of times the bear enters the water for at least 5 sec during the 72-h period.

Other sensors with potential applications in wildlife research include devices for measuring battery voltage, atmospheric pressure (i.e., determining the animal's elevation or altitude), heart rate, and body temperature. Problems with sensor calibration and small ranges of change might reduce the utility of atmospheric pressure sensors. Furthermore, errors in determining animal location caused by assuming that the animal is at sea level when it is actually at a higher elevation might not be large enough to justify altitude sensors and additional processing for correcting location estimates (see *Location Determination, Location Accuracy and Precision in Wildlife Applications*). This might not

be the case for high-flying birds, but the additional weight and expense of altitude sensors may lessen their utility.

Numerous researchers have used heart rate as an index of energy expenditures by animals (e.g., Renecker et al. 1982; Fancy and White 1986). A separate, fully sealed, implantable unit that transmits to a transceiver attached to a neck collar is the preferred system for monitoring heart rate, body temperature, and other physiological measurements. Units with external wires have generally given poor results (e.g., Renecker et al. 1982; Renecker 1985). Such a design is technically feasible, but the receiver function within the PTT would increase the power requirements such that the PTT would probably have a lifetime of only a few weeks (Stan Tomkiewicz, Telonics, personal communication).

Location Accuracy and Precision in Wildlife Applications

Between April 1985 and October 1986, we obtained 1,265 locations for which the true location of the PTT was known within 50 m. The data set included PTT's set on the roofs of buildings in Alaska and Arizona, PTT's on captive animals kept in small pens, and PTT's that transmitted from sites of animal death. This data set was analyzed to determine the accuracy and precision of locations ob-

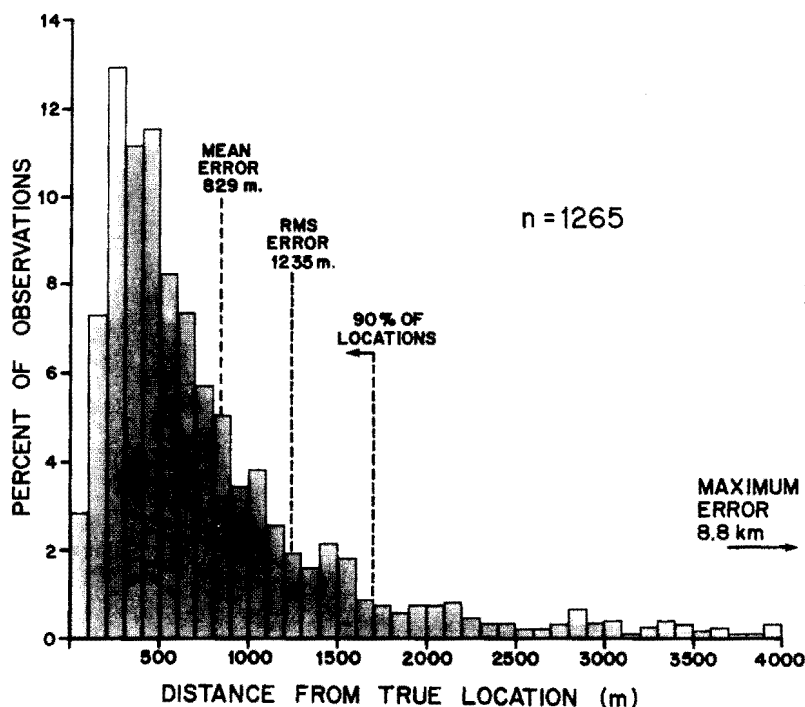

Fig. 29. Accuracy of Telonics second-generation transmitters used to track large mammals.

tained using the Argos system and the same Telonics PTT's deployed on animals. In addition, we used the TRACK program (Appendix A) to determine several characteristics of the satellite overpass (e.g., maximum satellite elevation, number of minutes above 5° elevation, minimum range to satellite) for each location in an attempt to identify overpass char-

acteristics having the greatest influence on location accuracy.

The mean locational error for the combined data set was 829 m (± 26 SE; Fig. 29, Table 9). Ninety percent of the estimated locations were within 1,700 m of the true location, and the maximum error was 8.8 km. Because Argos assumed in the calcula-

Table 9. Locational errors (in meters) for caribou and polar bear transmitters for which the true location of the transmitter was known.

Location	Elevation (m)	Site	One pass by one satellite			Two passes by one satellite			Two passes by two satellites			Combined		
			n	\bar{x}	SE	n	\bar{x}	SE	n	\bar{x}	SE	n	\bar{x}	SE
33.383N 111.806W	450	7	127	754	51	64	796	91				191	678	46
64.839N 147.704W	250	4	273	1,177	86	144	536	38	130	580	45	547	866	47
64.880N 147.686W	210	3	35	1,206	169	7	786	185	10	942	125	52	1,099	120
64.886N 147.862W	263	5	13	1,117	166	1	3,721		7	1,186	232	21	1,264	175
67.909N 147.018W	850	9	27	907	147	6	998	377	23	1,115	118	56	1,002	94
68.456N 137.936W	370	6	149	907	68	58	520	378	87	586	76	294	736	43
68.589N 143.831W	830	8	32	1,122	206							32	1,122	206
70.123N 143.614W	20	1	22	536	74	6	512	115	12	456	43	40	508	46
70.124N 143.612W	20	2	16	601	86	5	309	43	11	472	82	32	511	54
All sites			694	995	41	291	612	33	280	644	36	1,265	829	26

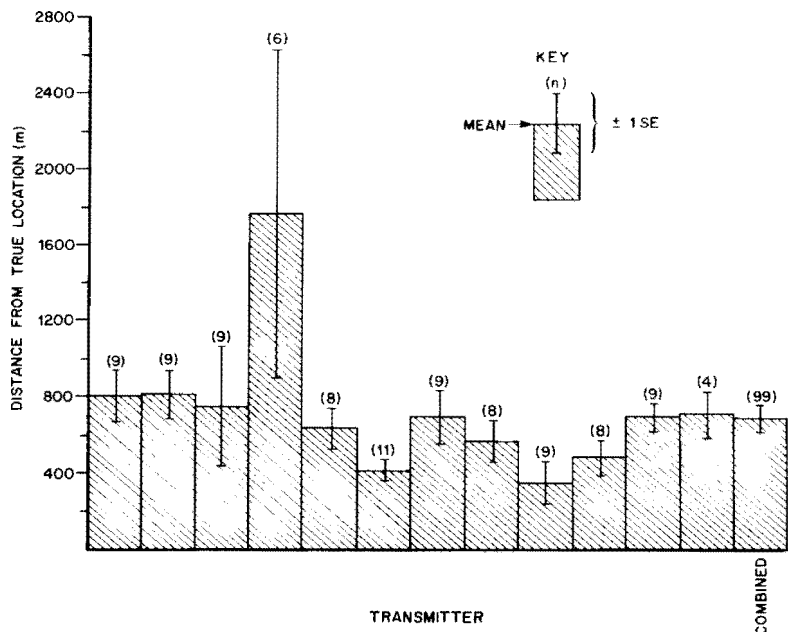

Fig. 30. Differences in performance of 12 platform transmitter terminals (PTT's) transmitting from the same location during the same 12-h period. The ambient temperature during the experiment ranged between -12° and -4°C .

tions that the animal was at sea level, a portion of this error can be attributed to an elevational effect; however, no relation (regression; $n = 1,265$; $r^2 = 0.001$; $p > 0.10$) between locational error (or the longitudinal component of location error, which is most sensitive to elevation effects) and PTT elevation was detected (Fig. 28).

Two factors that probably account for most of the locational error are errors in estimating position of the satellite within its orbit and stability of the oscillator within each PTT (Argos 1984; Rosso 1985). The importance of oscillator stability and temperature-compensation circuitry is reflected in the mean locational error and number of locations fixed for 12 PTT's transmitting from the same location during the same 12-h period (Fig. 30). Ambient temperatures during this 12-h period ranged between -4° and -12°C . Although each PTT transmitted at similar repetition rates during the same satellite overpasses, the number of locations fixed ranged from 4 to 11, and mean errors ranged from 351 m to 1,782 m (Fig. 30). Oscillator stability and the differential effect of temperature on the uplink frequency of each PTT might also account for the poor relation between site elevation and the longitudinal component of locational error (Fig. 28).

Analyses for directional bias were conducted using the azimuth between the true PTT location and each calculated location. For the combined data set

($n = 1,265$), we found a significant directional bias (Hotelling's T^2 test; $T^2 = 82$; $p < 0.001$; Batschelet 1981) with a mean angle of 335° . When data for each site were analyzed separately, a significant directional bias was found for all but one of the nine sites (Fig. 31). The mean angle between the true and calculated location for each site was within the northwest quadrant (i.e., 270 – 360°) for eight of the nine sites (Fig. 31). The directional bias may result from differences between the earth coordinate system we used (Clark 1866 ellipsoid; Snyder 1982) and that used by Service Argos (WGS [World Geographic System] 1984 ellipsoid).

We tested the hypothesis that this directional bias in calculated locations was a result of the orientation of satellite overpasses relative to the transmitters by conducting a circular-circular correlation between the azimuth of the satellite at its point of greatest elevation above the horizon and the azimuth to the calculated location. No significant correlation was found ($p > 0.05$; Batschelet 1981).

The relations between locational error and specific characteristics of the satellite overpass are somewhat difficult to determine because many of the overpass characteristics are associated. For example, an overpass that barely rises above the horizon (e.g., maximum overpass $< 10^{\circ}$) will be in view for only a few minutes and the minimum distance between the satellite and the PTT will be relatively

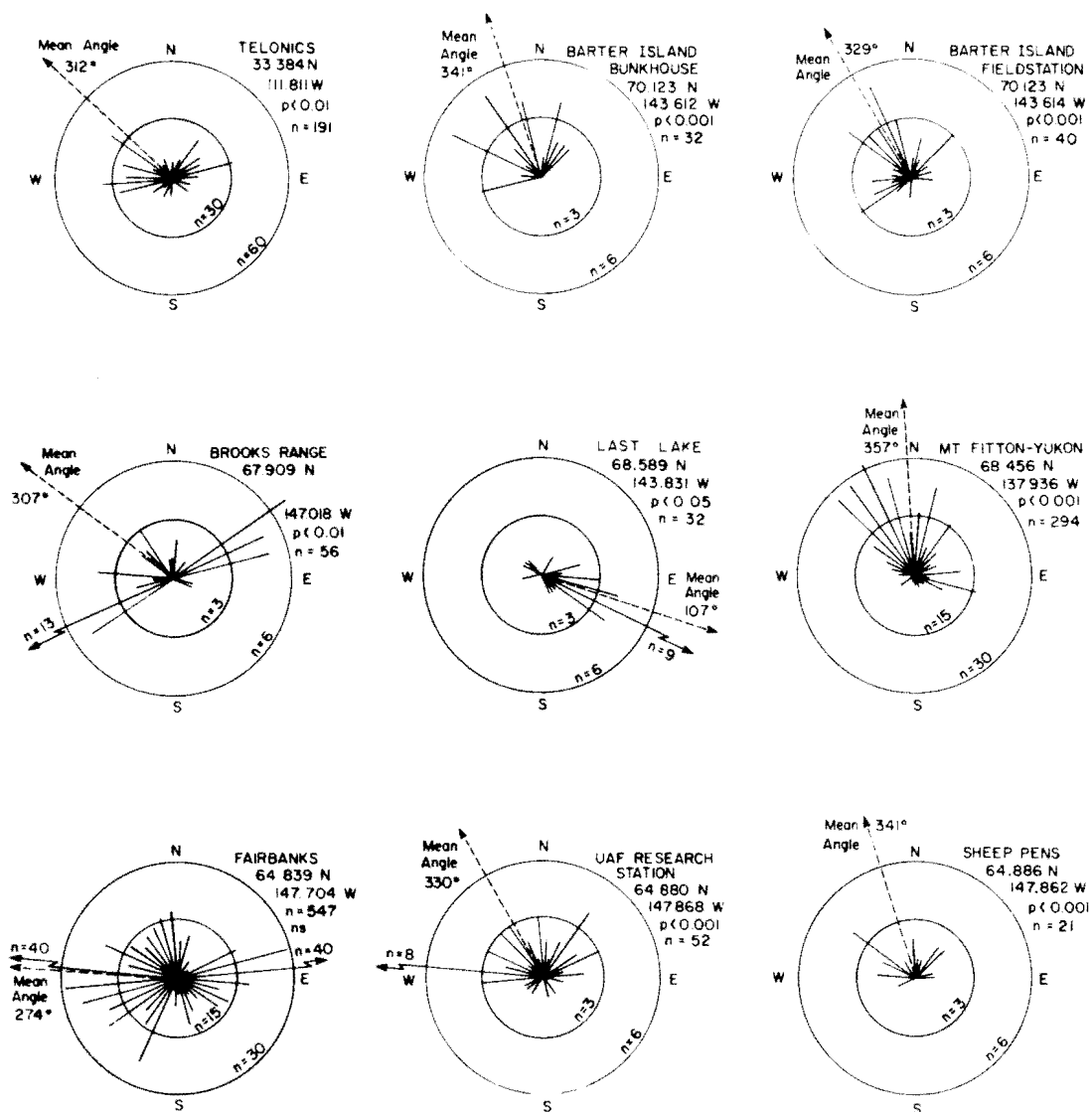

Fig. 31. Distribution of azimuths between the true location of a transmitter and the location calculated by Argos for nine sites. The mean angle and significance level (Hotelling's T^2 test for directional bias) is shown for each site.

large, whereas an overpass with a high overpass angle will be in view for a longer period and have a smaller minimum range between the satellite and PTT. These interrelations can be seen to a certain extent in Figs. 32-34. The more accurate locations occur when the maximum overpass angle is between 20° and 50° (Fig. 32). (We discount the 80 - 89° class because of the small sample size and the fact that Argos typically will not calculate locations for PTT's very close to the satellite ground track.) The intermediate distance classes (Fig. 33) that correspond

to the intermediate elevation classes (Fig. 32) also have the lowest mean errors in location.

Reliability of Transmitter Packages

Between April 1985 and November 1986, we deployed 32 Telonics PTT's on caribou and 36 on polar bears. Within the first 6 months of their operation, the UHF signal for 3 of the 32 caribou PTT's (9%) and 10 of the 36 polar bear PTT's (28%) stopped functioning (Fig. 35). The higher failure rate

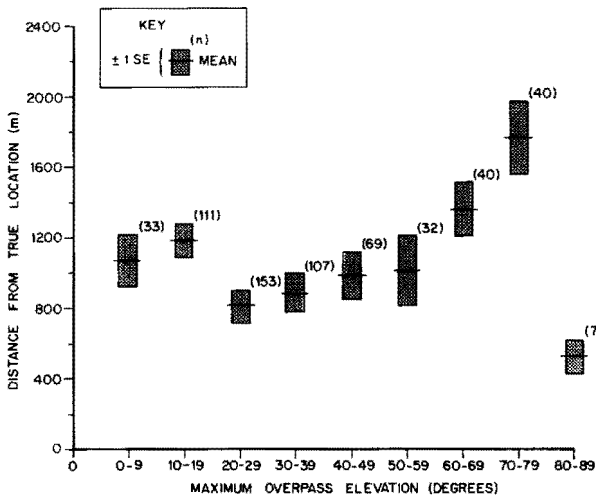

Fig. 32. Relation between locational error and the maximum elevation of the satellite overpass relative to the transmitter. Errors in locations calculated from Doppler measurements made during more than one overpass are excluded.

of polar bear units may be caused by greater abuse. However, variations in battery quality, or insufficient signal strength because of the encased antenna on the polar bear units, or the closeness of the antenna to the large mass of the animal (i.e., the

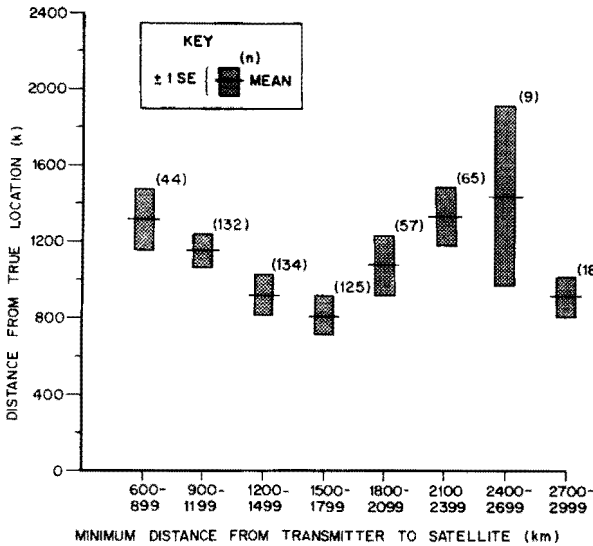

Fig. 33. Relation between locational error and the minimum range (km) between the transmitter and the satellite.

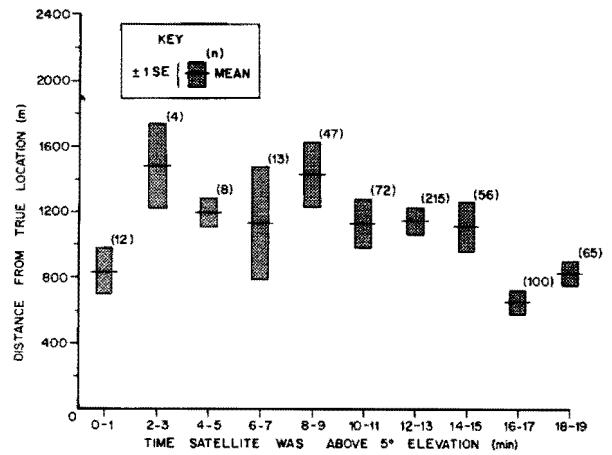

Fig. 34. Relation between locational error and the number of minutes the satellite was at least 5° above the horizon relative to the transmitter.

VSWR effect; Appendix D) may also have contributed to the higher failure rate.

Caribou PTT's had a theoretical battery life of 1 year on a duty cycle of 6 h on-18 h off, but the theoretical life is based on temperature patterns that

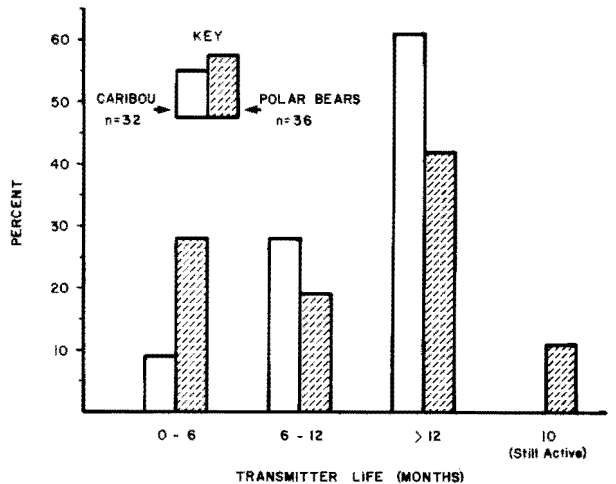

Fig. 35. Number of months of operation realized for caribou transmitters ($n = 20$) and polar bear transmitters ($n = 36$) deployed before September 1986. Caribou units transmitted 6 h/day, whereas polar bear units transmitted 12 h every third day.

may not be realized in the field (e.g., the number of days with ambient temperatures below -20°C may be greater than that assumed). Of the 31 caribou PTT's that were on caribou for a year (one was retrieved and used in sensor calibration studies with captive animals), 8 (26%) stopped transmitting 9–12 months after deployment because of battery depletion. Nineteen PTT's (61%) transmitted for the full 12 months.

Polar bear PTT's had a theoretical battery life of 18 months based on 12 h of transmission every third day. Fifteen PTT's have operated in excess of 1 year, including 12 that were retrieved after approximately 12 months and replaced with new PTT's (Fig. 35). Four PTT's deployed in November 1986 were still operational after 10 months.

Some PTT's transmitted intermittently or provided relatively few locations even though they continued to provide occasional data (Figs. 36–37). If a transmitter failed or its batteries were exhausted, the days following the last transmission were not considered as "possible days" in these analyses. Weak signal strengths caused by low batteries, or the encased antenna and VSWR effect for bears, could explain some of our results, although the PTT's that regularly provided sensor data but few locations may have had problems with oscillator stability throughout their temperature range. At least one message was received from polar bear

transmitters on 91.6% of the active PTT-days, compared to 96.6% of the active PTT-days for caribou. At least one location for each animal was received on 56.8% of the active PTT-days for polar bears and on 90.2% of the possible days for caribou.

Five PTT's transmitted outside their programmed duty cycle. In one case, a caribou PTT continued to transmit 6 h/day, but the starting time for the 6-h window was different than the original starting time. The duty cycle shift occurred when the caribou was killed. The canister had an indentation caused by a bear's tooth, and the shock of being crushed probably caused the shift in the duty cycle. Four polar bear units, originally programmed to operate 12 h every third day, have also changed their duty cycles. In two cases, the PTT's transmitted continuously for a period, then returned to a cycle of 12 h on–60 h off, but with a different starting time. The cause of these shifts in duty cycles has not been ascertained, but a shock to the canister, or temperatures below the lower operating specification (-40°C) may have been responsible.

Real-time Processing with a Local User Terminal

A Local User Terminal (LUT) receives the real-time VHF and S-band (see Appendix D) satellite downlinks (Fig. 14) to process Argos data. The

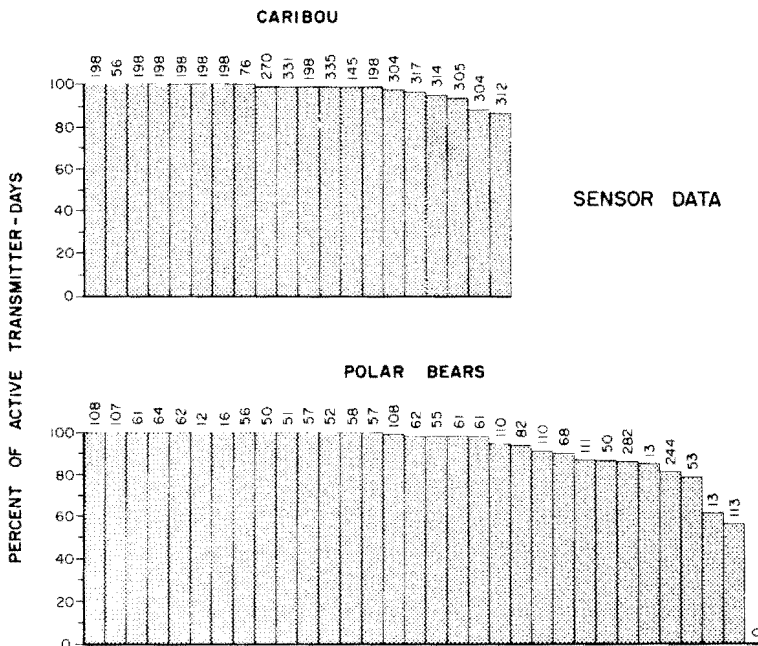

Fig. 36. Percent of expected days when sensor data were received for each transmitter. Platform transmitter terminals (PTT's) with low values transmitted intermittently. Numbers above each column represent the number of days for which sensor data were received for each PTT.

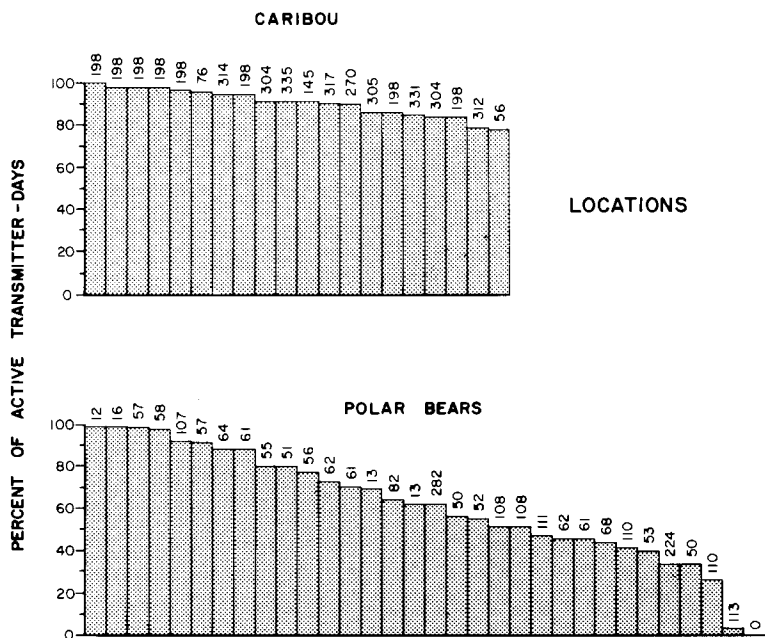

Fig. 37. Percent of expected days when at least one location was obtained for each active platform transmitter terminal (PTT). Numbers above each column represent the number of days when a location was expected for each PTT.

primary advantages of a LUT are avoidance of the usual 3–5 h delay through standard Argos processing; greater processing flexibility and availability of Doppler data, signal strengths, and other information not currently provided by System Argos; and cost-effectiveness for multi-year programs with 10 or more PTT's. In certain applications where few messages are received during each satellite pass (e.g., whales, polar bears in dens), use of a LUT and special processing procedures is the only means of determining an animal's location (although the locational error may be relatively large).

LUT's have three primary disadvantages. They have a high initial cost of \$30,000–\$50,000. They produce fewer data because both the transmitter and the LUT must be within view of the satellite (whereas Service Argos provides tape-recorded transmissions received when only the animal was within view of the satellite) and because background noise at the horizon can interfere with data acquisition. They also have increased likelihood of data loss because of equipment failures, power outages, or software problems. For good results, the LUT should be within 2,000 km of the animal; the amount of potential data increases as the distance between the LUT and the transmitter decreases.

LUT users must still pay Service Argos for partial use of the system, but at a greatly reduced rate. The minimum cost, for which Argos provides no data

backup, is 12% of the charge for standard service. Service Argos will also provide a backup (data archival) service for 20% of the price of standard service; the backup service will archive data but not make it available through standard methods. In the latter case, a user requesting data for a particular month will be charged for a full month of standard processing, plus a service fee.

Several LUT manufacturers are listed in Table 8. Models using a fixed, omni-directional antenna (e.g., Microlog Corp., Polar Research Labs) are more portable, but will have potentially greater problems with background noise near the horizon in developed areas. The LUT built by Telonics, Inc., uses a tracking yagi antenna to increase the probability of message reception, but at the expense of system portability. We have used only the Telonics LUT, but information from each of the manufacturers in the United States listed in Table 8 indicates that the basic operation of each of the LUT's is similar. All utilize the VHF downlink frequencies (136.77 and 137.77 MHz) containing data from each satellite and automatically lock onto the proper frequency depending on which satellite is in view. The data stream includes data from all experiments onboard the satellite, and each LUT extracts the 9 bytes of Argos data from the 104 bytes in each frame. Following the satellite pass, the LUT's utilize satellite ephemeris data, reference platform data,

and the Doppler data from each PTT to calculate PTT positions.

We have recently written computer programs for our LUT that will allow us to compare the quantity and quality of data received via the LUT versus data received and processed by Service Argos. These comparisons, and an analysis of the cost effectiveness of the two data retrieval approaches, will be presented in a later report.

Effects of the Collar on the Animal

The 2-kg collar has minimal effect on polar bears. Beneath collars retrieved after 12–18 months, the bear's fur is usually matted, but no instance of excessive rubbing, hair loss, or other damage has been noted. A captive polar bear in a zoo repeatedly tried to dislodge the collar using her paws, but otherwise we have not found any effect of the collars on bear behavior.

Collars deployed on caribou in 1984 and 1985 might have increased the vulnerability of the collared caribou to predation (2 caribou in 1984 and 2 in 1985 were apparently killed by brown bears), and 3 of the 10 collars retrieved in March 1986, after being worn for approximately 1 year, had rubbed against the caribou's neck and caused bleeding and soreness. Collars deployed after March 1986 have been secured more tightly around the caribou's neck, and since that time we have noted few problems with excessive rubbing or predation that can be attributed to the collar. We still find that on some individuals the relatively large mass of the transmitter package causes the collar to swing forward and backward when the caribou runs, even when the collar is placed very tightly around the neck. Some hair loss around the collars has been noted, but tightening the collar has apparently solved the more serious problems encountered during the first 2 years of the project.

Geographic Information Systems

Geographic information systems (GIS) are powerful tools for storing, partitioning, analyzing, and interpreting spatially oriented data. These systems provide efficient methods for mapping animal locations and movements and for quantifying animal interactions with environmental information. The fundamental concept for processing telemetry data

within a GIS is to overlay or intersect animal locations with environmental information. Examples of useful environmental data include topography, vegetation, soils, hydrology, distributions of food resources, competitors or predators, land ownership, existing proposed development structures, or combinations of the above. Maps can be displayed for visual interpretation or processed by a variety of analytical programs within the GIS.

The needs of the manager and the creativity of the researcher will determine specific GIS requirements and applications. Like any computer program, a GIS is simply a tool for achieving accurate results in an efficient manner. If plotting a few animals onto topographic base maps is the full extent of geoprocessing required, then investing in a GIS would not be cost effective. However, as the volume of locational data increases or as spatial analyses become more complex, the usefulness of a GIS increases. Hardware requirements to support a GIS software package include a computer with sufficient memory and storage capacity and a compatible graphics terminal. GIS packages are available that operate on personal computers as well as mainframe computers. A graphic pen, ink-jet, or electrostatic plotter is necessary to create hard-copy displays. Topographic and landcover maps are available in digital format for much of the country, or if more specific maps are required, a user could acquire a digitizing table or contract with one of several private companies that provide digitizing services.

Geographic information systems process two general types of geographic data: vector and raster. Vector data refers to points, lines, and polygons, whereas raster refers to maps that consist of uniform-sized cells (pixels) that collectively form a matrix within the map boundary. A GIS operates on either vector or raster data, although a few GIS packages have both vector and raster processors, as well as the capability to convert vector data to raster format and vice versa, thus allowing the analytical capacities of both operating systems to be exploited.

The detailed data we receive from Argos on 9-track tape each month are processed by a series of FORTRAN programs and system utilities (Fig. 38; Appendix A) and are then entered into the GIS with environmental data bases. Various GIS commands are then used to analyze the data bases and to print out reports or produce graphics. One of the GIS's we use, the Map Overlay and Statistical System (MOSS), can be used to process point or vec-

DATA PROCESSING PROCEDURES

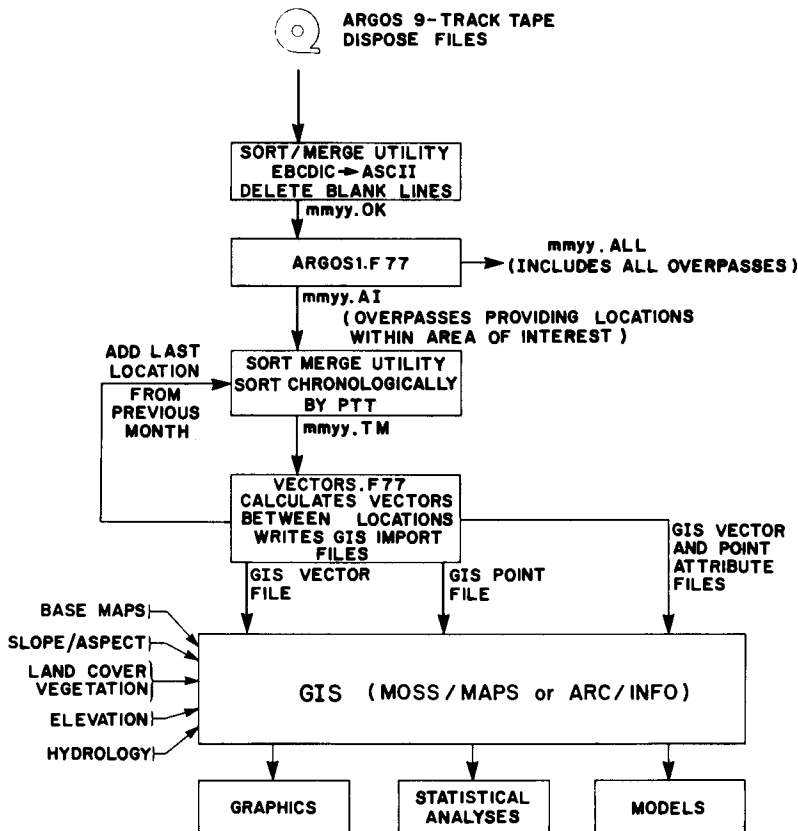

Fig. 38. Procedure used to process Argos Dispose files and enter animal locations into the MOSS/MAPS geographic information system.

tor data such as animal locations, movement vectors between locations, and linear features such as contours, rivers, coastlines, or geographic boundaries, whereas Map Analysis and Processing System (MAPS) commands are designed to process rasterized (cell) data such as Landsat vegetation data. Data bases from the ARC/INFO GIS can be converted for use by MOSS/MAPS (or vice versa) using procedures outlined in Dearborn (1986).

One basic use of a GIS is to produce maps of animal locations and movements across the study area. Animal movements can be chronologically displayed on a graphics terminal, producing dynamic images of animal movements relative to one another. This type of visual analysis can elucidate useful information during dispersal, migration, or predator-prey interactions. Animal locations can also be overlaid onto digital base maps that delineate features of interest within the study area, or the animal data can be plotted directly onto topographic quadrangles (or similar hard-copy base maps). The

movements of transmitter-collared polar bears in the Beaufort and Chukchi seas during 1985–86 are shown in Fig. 39. Two objectives of the polar bear research are to delineate population or subpopulation boundaries and to determine the extent to which these populations are shared with the USSR or Canada. Detailed movements of bears are shown in Figs. 40–42. The movements shown in Fig. 42 are particularly interesting because the polar bear remained along the coastline in late summer after the pack ice had retreated offshore then moved through the Bering Strait and traversed the mountains of the Chukotsk Peninsula during late December 1986.

Movement patterns of two radio-collared caribou of the international Porcupine Caribou Herd in 1985–86 are shown in Figs. 43–44. The satellite-tracked caribou have shown little fidelity to specific wintering areas, migration routes, or postcalving areas during the first 3 years of study. Movements of both the Porcupine Herd caribou and the two radio-collared caribou of the Central Arctic Herd

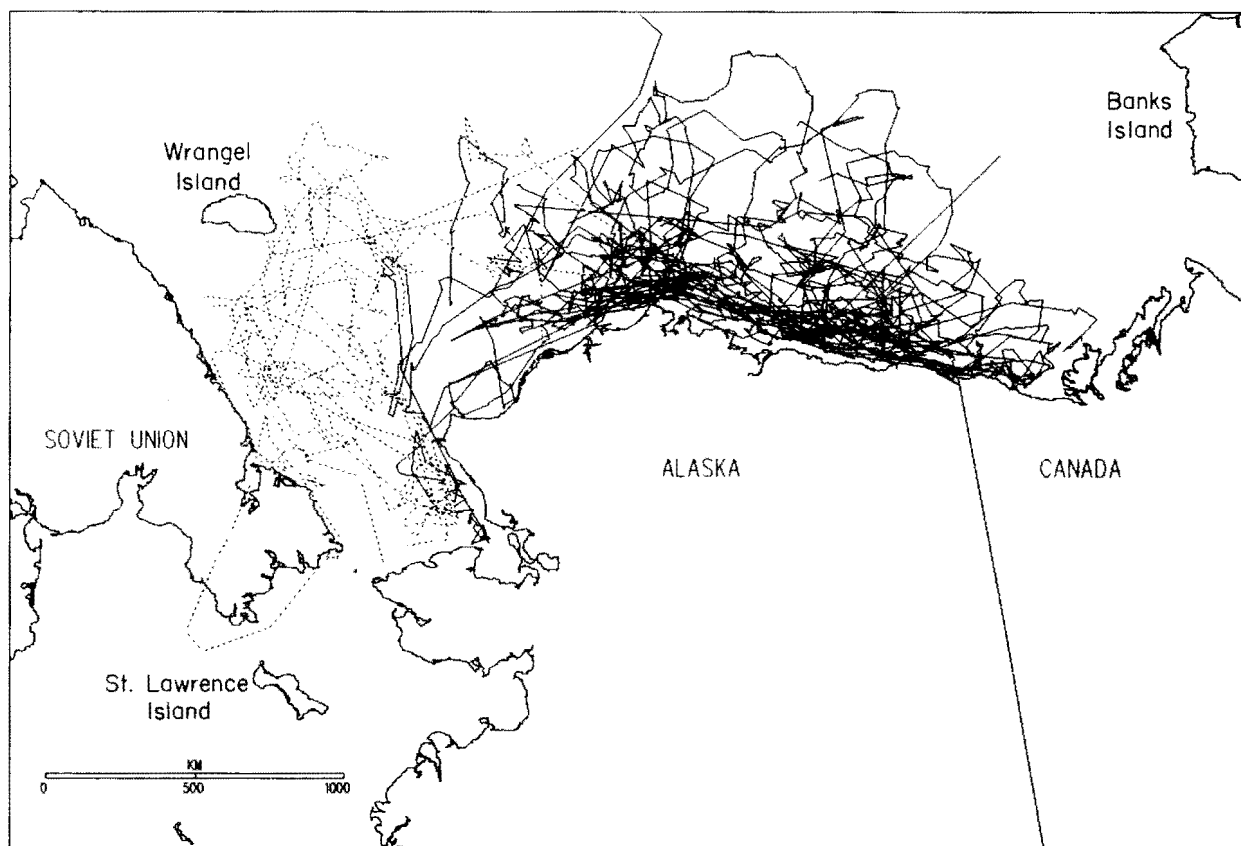

Fig. 39. Movements of radio-collared polar bears in the Beaufort (solid lines) and Chukchi (dotted lines) seas during 1985–1986.

have been most extensive in July and least in mid-winter (Fig. 45). Annual movements of the Porcupine Herd as monitored by satellite have been much more extensive than previously realized, and during the first year caribou were tracked up to 4,070 km as they moved between and within seasonal ranges.

Specific management issues can be addressed using a GIS. For example, a base map of proposed oil and gas development structures on the coastal plain of the Arctic National Wildlife Refuge was digitized and entered into the GIS, and movements of radio-collared caribou were overlaid (Fig. 46). Within the GIS, 1-, 2-, and 3-km buffer zones (polygons) were generated around the proposed roads, pipelines, drill pads, and airstrips. Using GIS analytical programs, we summarized the number of caribou point locations within and outside of each buffer polygon, as well as the number of caribou vectors that intersected the buffer zones, roads, and pipelines. This information addressed

issues relating to disturbance assessment and mitigative measures.

The caribou–oil development example (Fig. 46) illustrated a technique for analyzing the interaction between animal distributions and existing or proposed environmental scenarios. Other wildlife management issues might include effect of clearcuts, prescribed burns, roads, powerline corridors, predator–prey distributions, competitor distributions, hunting zones, or refuge boundaries. Furthermore, attribute information associated with each point or vector is useful to create subsets of animal locations and investigate environmental relations more specifically. For example, biologists and managers may be interested in the activity of female animals within 3 miles of roads during a hunting season when ambient temperatures are below freezing.

GIS processing with raster data facilitates other types of analyses. Remote sensing of most environmental parameters by satellite imagery is recovered

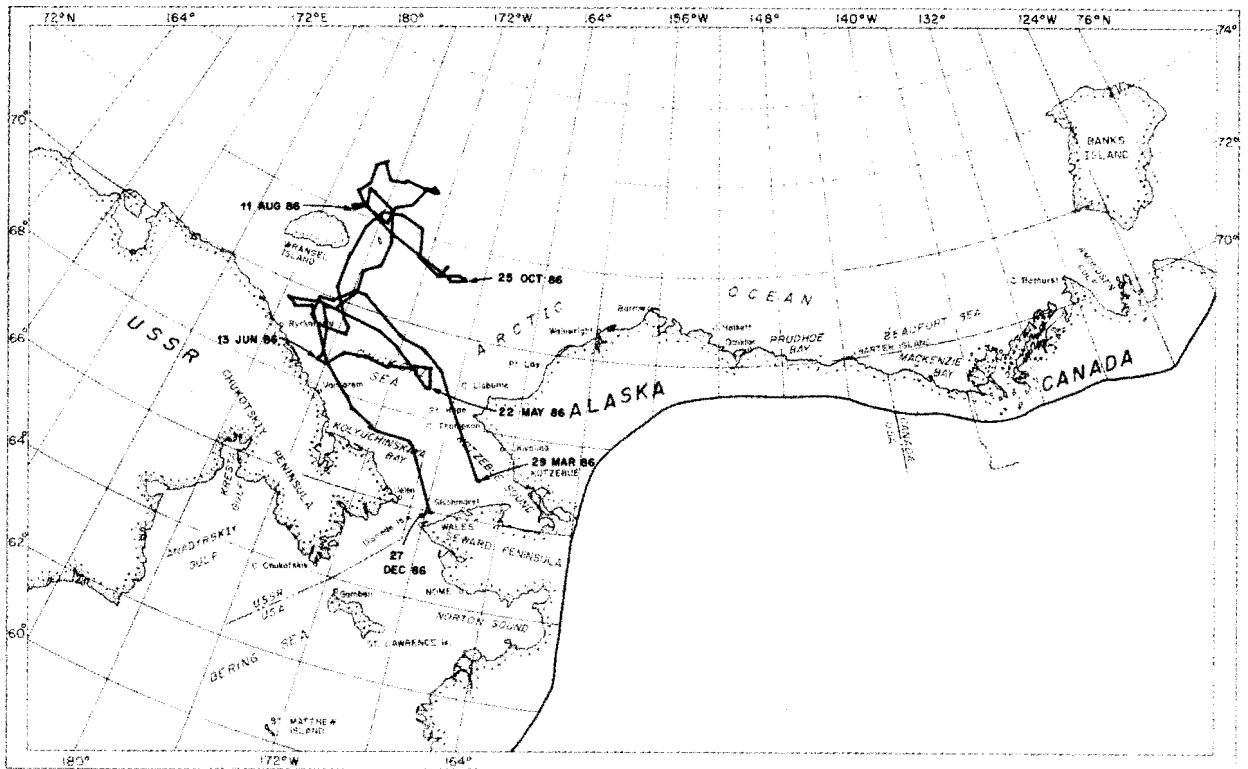

Fig. 40. Movements of a radio-collared female polar bear in the Chukchi Sea between March 1986 and December 1986.

as raster data and is often an economical and objective means for quantifying the landscape across broad geographic areas. Landsat landcover maps are an example of raster information. To illustrate the use of the GIS to combine telemetry and raster data bases, we conducted preliminary analyses to determine the association of the satellite-tracked caribou with various Landsat landcover types. A subset of caribou locations within the United States Geological Survey Demarcation Point quadrangle (scale 1:250,000) during May, June, and July 1986 was overlaid onto the landcover map. Landcover areas included within 1,750-m buffer zones around each caribou location were compared to the expected areas based on the occurrence of each landcover type within the quadrangle (Table 10). The 1,750-m buffer is based on our work that indicated that 90% of the satellite-determined locations were within 1,750 m of the true PTT location. Similar analyses could be conducted to compare use versus availability of other base maps such as intervals of elevation, slope, and aspect.

Programs within a GIS often allow the information in one or more raster data layers to be redefined or modeled to produce a new raster data layer. For example, a diversity index can be derived for each cell (or polygon in a vector map) based on the values of surrounding cells and the resulting map used to investigate animal associations with environmental heterogeneity. Base maps can be produced that delineate areas where different cell types occur adjacent to one another, allowing a researcher to evaluate how species use different habitat classes. We reclassified the Landsat landcover types on the Arctic National Wildlife Refuge coastal plain into two categories: insect-harassment habitat and insect-relief habitat (Fig. 47). This model allows us to investigate caribou use of insect relief areas during periods of high and low insect harassment.

Conclusions

Satellite telemetry improves the logistics of data acquisition by circumventing many of the defici-

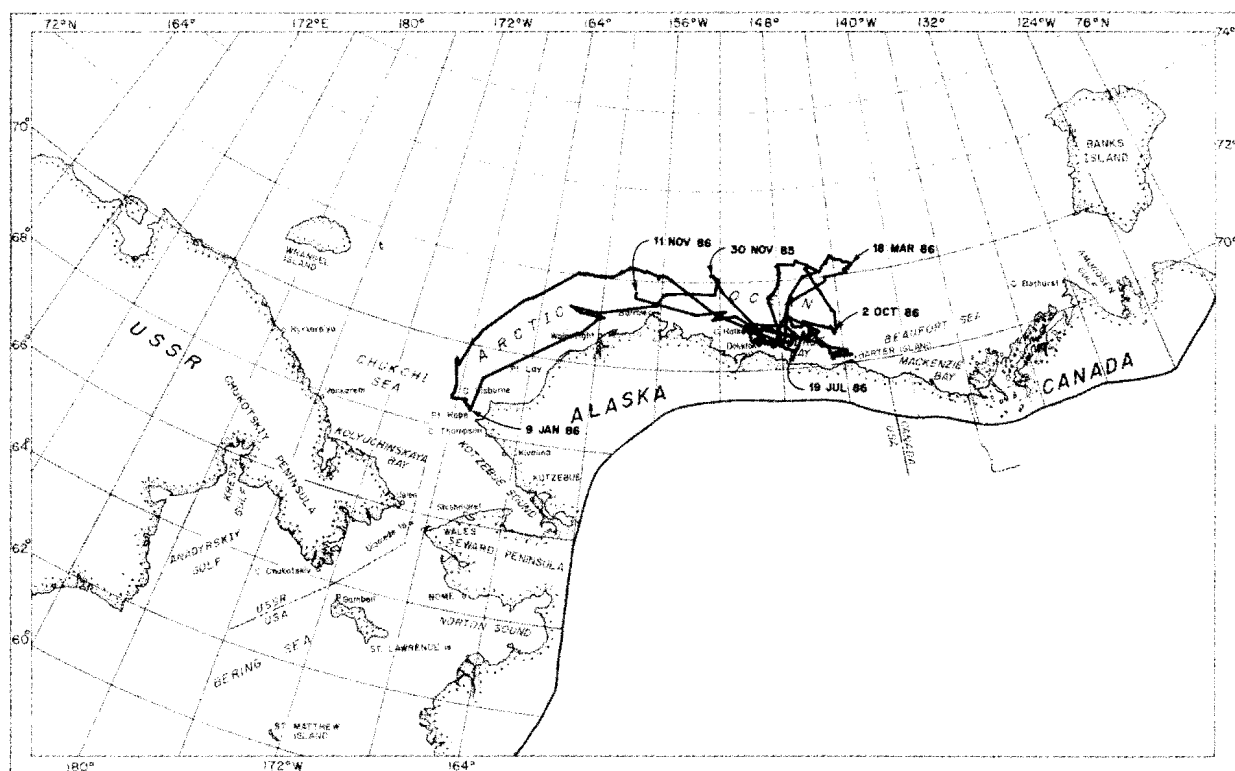

Fig. 41. Movements of a radio-collared female polar bear in the Beaufort Sea between November 1985 and November 1986.

encies encountered with conventional telemetry techniques. Factors such as hazardous weather conditions, darkness, international boundaries, remoteness, and extensive animal movements do not hinder the systematic collection of data. Under such circumstances, satellite-tracking can provide data more objectively, more accurately, and more cost effectively than conventional telemetry methods. In addition to locational information, sensors within the satellite-compatible transmitters can monitor aspects of an animal's environment, behavior, or physiology. Satellites are also used to monitor other parameters relevant to wildlife studies, such as weather, landcover, topography, or ocean currents. The combination of GIS technology with satellite telemetry, remote sensing, and computer processing has provided a powerful tool for wildlife managers and researchers. Geographic information systems provide the capability to efficiently investigate relations between animals and their physical or biological environment. These state-of-the-art technological tools have greatly increased our ability

to monitor caribou, muskox, and polar bear populations in Alaska. The systems described here can aid researchers working with other species in other areas.

Acknowledgments

This study was supported by administrative funds from the Pittman-Robertson program and by the U.S. Fish and Wildlife Service. We thank the many people who assisted with animal capture and handling, data analysis, and report preparation. We particularly thank Ken Whitten of the Alaska Department of Fish and Game, Tom McCabe and Fran Mauer of the Arctic National Wildlife Refuge, Craig Gardner of the Alaska Fish and Wildlife Research Center, Mike Hansen of the University of Alaska, Don Russell and Wendy Nixon of the Canadian Wildlife Service, and Cor Smits of the Yukon Department of Renewable Resources for their assistance with field operations. Frank D'Erchia,

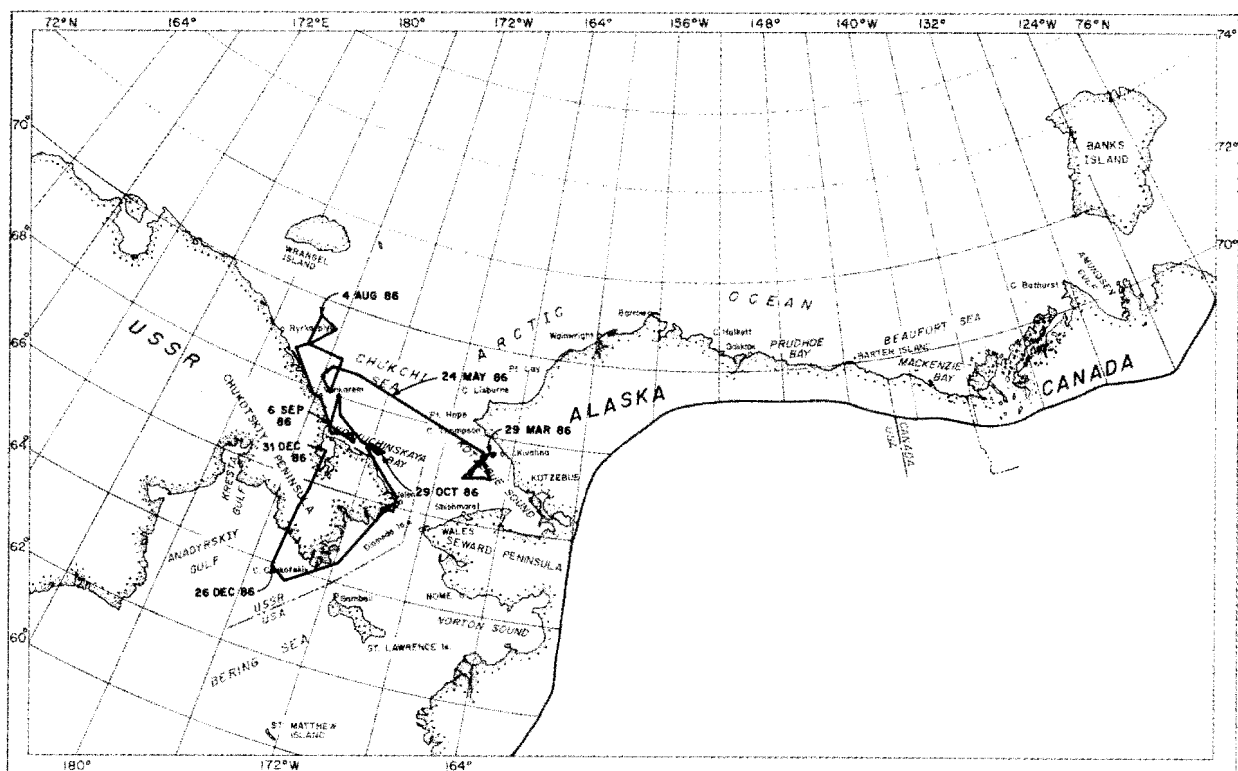

Fig. 42. Movements of a female polar bear in the Chukchi and Bering seas between March 1986 and December 1986.

Jim Greslin, Mike Hansen, Curvin Metzler, Dan Reed, and Jesse Venable assisted with computer programming and data analysis. We thank Margaret McClure, Steve Morstad, Tom Paragi, and Ulf Petersen for volunteering to work with captive animals. Bob White and Dale Guthrie of the University of Alaska provided access to captive animals for the activity sensor work.

We thank the staff of Telonics, Inc., for their efforts in technical matters and in helping us to meet deadlines; Archie Shaw and Lisa Morakis of Service Argos helped us to understand and use the Argos system more effectively.

We are indebted to Deniece Roman for typing this manuscript in record time. Brian Blevins, Joe Enzweiler, and Betsy Sturm produced the figures.

References

Argentiero, P., and J. Marini. 1979. Ambiguity resolution for satellite Doppler positioning systems. *IEEE (Inst.*

- Electr. Electron. Eng.) Trans. Aerospace Electr. Syst.* 15:439-447.
- Argos. 1978. User's guide—satellite based data collection and location system. Service Argos, Toulouse, France. 36 pp.
- Argos. 1984. Location and data collection satellite system user's guide. Service Argos, Toulouse, France. 36 pp.
- Barnes, J. C., and M. D. Smallwood. 1982. Tiros-N series direct readout services user's guide. NOAA special report. Washington, D.C. 132 pp.
- Batschelet, E. 1981. *Circular statistics in biology.* Academic Press, New York. 371 pp.
- Brooks, D. R. 1977. An introduction to orbit dynamics and its application to satellite-based earth monitoring missions. NASA Reference Publ. 1009. Washington, D.C. 84 pp.
- Craighead, D. J. 1986. Movements of caribou in the western arctic herd. *Argos Newsl.* 26:1-2.
- Craighead, F. C., Jr., J. J. Craighead, C. E. Cote, and H. K. Buechner. 1972. Satellite and ground radio tracking of elk. Pages 99-111 in S. R. Galler, K. Schmidt-Koenig, G. J. Jacobs, and R. E. Belleville, eds. *Animal orientation and navigation—a symposium.* NASA Spec. Publ. 262. 606 pp.
- Craighead, J. J., F. C. Craighead, Jr., J. R. Varney, and C. E. Cote. 1971. Satellite monitoring of black bear. *Bioscience* 21:1206-1211.

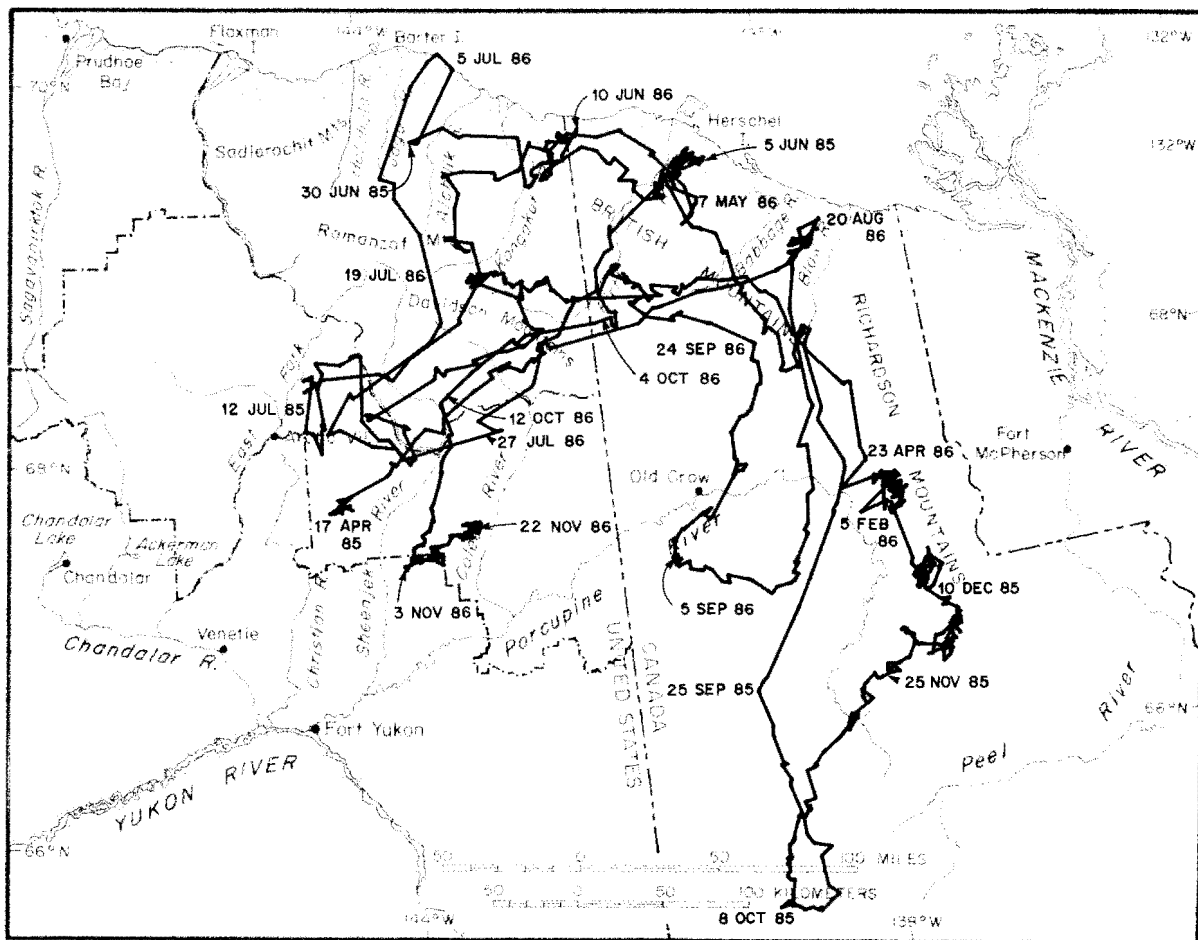

Fig. 43. Movements of an adult female caribou of the Porcupine Herd between April 1985 and December 1986.

- Curatolo, J. A. 1986. Evaluation of a satellite telemetry system for monitoring movements of caribou. *Rangifer*, Spec. Issue No. 1:73-80.
- Dearborn, B. C. 1986. Data exchange algorithms between ARC/INFO and MOSS databases. Sixth annual ESRI user conference, Redlands, Calif. 16 pp.
- Fancy, S. G., and R. G. White. 1986. Predicting energy expenditure for activities of caribou from heart rates. *Rangifer*, Spec. Issue No. 1:123-130.
- French, J. 1986. Environmental housings for animal PTT's. *Argos Newsl.* 26:7-9.
- Fuller, M. R., N. Levanon, T. E. Strikwerda, W. S. Seegar, J. Wall, H. D. Black, F. P. Ward, P. W. Howey, and J. Partelow. 1984. Feasibility of a bird-borne transmitter for tracking via satellite. Pages 1-6 in Proc. 8th Int. Symp. Biotelemetry, Dubrovnik, Yugoslavia, May 6-12, 1984.
- Jennings, J. G., and W. F. Gandy. 1980. Tracking pelagic dolphins by satellite. Pages 753-755 in C. J. Amlaner, Jr., and D. W. MacDonald, eds. *A handbook on biotelemetry and radio tracking*. Pergamon Press, Oxford, England. 804 pp.
- Kolz, A. L., J. W. Lentfer, and H. G. Fallick. 1980. Satellite radio tracking of polar bears instrumented in Alaska. Pages 743-752 in C. J. Amlaner, Jr., and D. W. MacDonald, eds. *A handbook on biotelemetry and radio tracking*. Pergamon Press, Oxford. 804 pp.
- Larsen, T., C. Jonkel, and C. Vibe. 1983. Satellite radio-tracking of polar bears between Svalbard and Greenland. *Int. Conf. Bear Res. Manage.* 5:230-237.
- Lentfer, J. W., and D. DeMaster. 1982. Satellite radio tracking of polar bears. Pages 52-53 in C. Cote, R. Taylor, and E. Gilbert, eds. *Nimbus-6 random access measurement system applications experiments*. NASA SP-457, Washington, D.C. 99 pp.
- Levanon, N. 1984. The theoretical bounds on random errors in satellite Doppler navigations. *IEEE (Inst. Electr. Electron. Eng.) Trans. Aerospace Electronic Sys.* 20:810-816.
- Mate, B. R. 1984. Argos-monitored whale tracking ex-

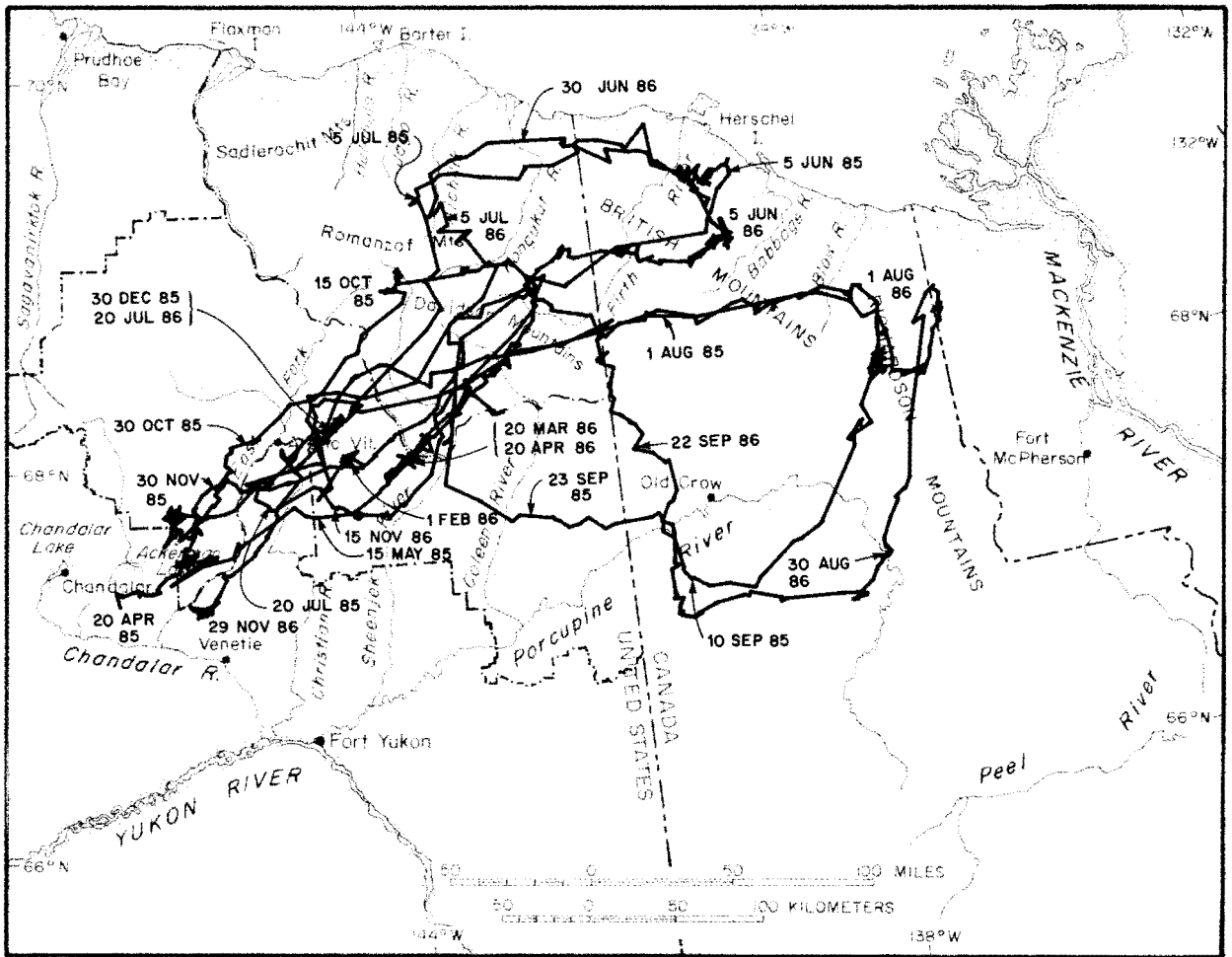

Fig. 44. Movements of an adult female caribou of the Porcupine Herd between April 1985 and December 1986.

- amines the three-dimensional dive characteristics of whales. Proc. Argos Users Conf., Seattle, Washington, 21-23 May 1984.
- Mate, B. R., D. Beaty, C. Hoisington, R. Kutz, and M. L. Mate. 1983. Satellite monitoring of humpback whale diving behavior and movements. Unpublished progress report to Minerals Management Service, Alaska Outer Continental Shelf Program Office, Anchorage. 24 pp.
- Mate, B. R., G. Rathbun, and J. Reed. 1986. An Argos-monitored radio tag for tracking manatees. *Argos Newsl.* 26:3-6.
- Pank, L. F., W. L. Regelin, D. Beaty, and J. A. Curatolo. 1985. Performance of a prototype satellite tracking system for caribou. Pages 97-118 in R. W. Week and F. M. Long, eds. Proc. 5th Int. Conf. Wildl. Biotelemetry. Laramie, Wyo. 118 pp.
- Priede, I. G. 1982. Tracking of basking sharks. Page 73 in C. Cote, R. Taylor, and E. Gilbert, eds. Nimbus-6 random access measurement system applications experiments. NASA SP-457, Washington, D.C. 99 pp.
- Rathbun, G. B., J. P. Reid, and G. Carowan. In press. Manatee (*Trichechus manatus*) distribution and movement patterns in northwestern peninsular Florida. Fl. Mar. Res. Publ.
- Renecker, L. A. 1985. Bioenergetics and behavior of moose in the boreal aspen forest. Ph.D. thesis, University of Alberta, Edmonton. 265 pp.
- Renecker, L., R. J. Hudson, and D. J. Freddy. 1982. Heart rate as an index of energy expenditure in moose, using two telemetry systems. In Proc. 7th Int. Symp. Biotelemetry, Stanford, Calif.
- Reynolds, P. E. 1986. Movement and activity patterns of a satellite-collared muskox in the Arctic National Wildlife Refuge, Alaska, 1984-85. In G. W. Garner and P. E. Reynolds, eds. 1985 update report, baseline study of the fish, wildlife, and their habits. U.S. Fish and Wildlife Service, Anchorage, Alaska. 1059 pp.
- Rosso, R. 1985. Location: theory and performance. *Argos Newsl.* 23:15-17.
- Schwab, A. 1982. The Tiros-N/NOAA A-G satellite

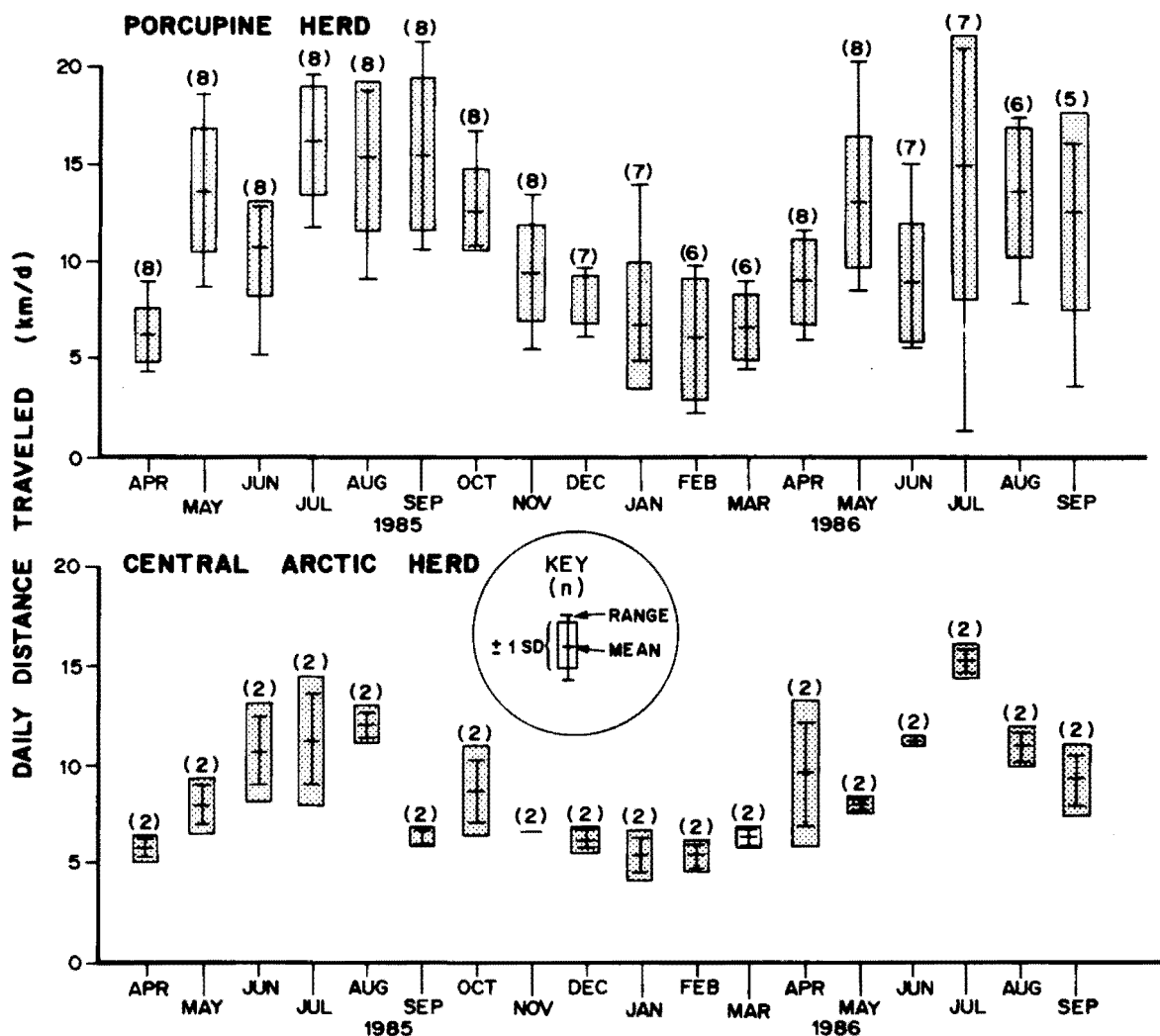

Fig. 45. Mean daily distance travelled (in km) by female caribou from two herds in northeastern Alaska, based on daily locations determined by satellite for 10 caribou.

- series. NOAA Technical Memorandum NESS 95. Washington, D.C. 75 pp.
- Schweinsburg, R. E., and L. J. Lee. 1982. Movements of four satellite-monitored polar bears in Lancaster Sound, Northwest Territories. *Arctic* 35:504-511.
- Snyder, J. P. 1982. Map projections used by the U.S. Geological Survey. *Geol. Surv. Bull.* 1532. 313 pp.
- Stoneburner, D. C. 1982. Sea turtle (*Caretta caretta*) migration and movements in the South Atlantic Ocean. Page 74 in C. Cote, R. Taylor, and E. Gilbert, eds. *Nimbus-6 random access measurement system applications experiments*. NASA SP-457, Washington, D.C. 99 pp.
- Strikwerda, T. E., H. D. Black, N. Levanon, and P. W. Howey. 1985. The bird-borne transmitter. *Johns Hopkins APL Tech. Dig.* 6:60-67.
- Strikwerda, T. E., M. R. Fuller, W. S. Seegar, P. W. Howey, and H. D. Black. 1986. Bird-borne satellite transmitter and location program. *Johns Hopkins APL Tech. Digest* 7:203-208.
- Taylor, M. K. 1982. The distribution and abundance of polar bears (*Ursus maritimus*) in the Beaufort and Chukchi seas. Ph.D. thesis, University of Minnesota, Minneapolis. 353 pp.
- Timko, R. E., and A. L. Kolz. 1982. Satellite sea turtle tracking. *Mar. Fish. Rev.* 44:19-24.
- Woods, E. G., and A. Kemmerer. 1982. Satellite-linked porpoise tracking system. Pages 70-71 in C. Cote, R. Taylor, and E. Gilbert, eds. *Nimbus-6 random access measurement system applications experiments*. NASA SP-457, Washington, D.C. 99 pp.

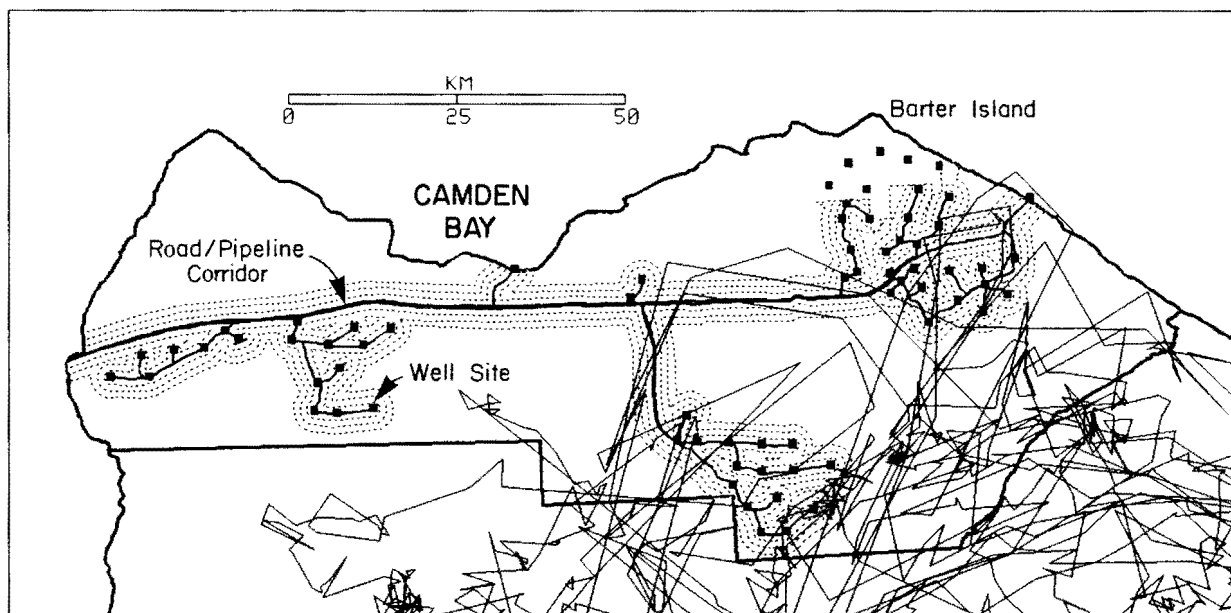

Fig. 46. Movements of radio-collared adult female caribou of the Porcupine Herd during May–August 1985 and 1986 in relation to a hypothetical oil development scenario on the coastal plain of the Arctic National Wildlife Refuge. Dotted lines represent zones of 1, 2, and 3 km around roads, pipelines, and well sites (squares).

Table 10. Area (ha) of Landsat landcover types within 1,750 m of satellite-determined caribou locations during May–July 1986 compared to expected area based on the occurrence of each type within the Demarcation Point quadrangle. Number in parentheses is the number of caribou locations overlaid onto the vegetation map each month.

Vegetation type	May (n = 59)		June (n = 299)		July (n = 140)	
	observed	expected	observed	expected	observed	expected
Open needleleaf	87	37	114	168	115	160
Alluvial deciduous scrub	1	3	2	12	14	11
Dry prostrate dwarf scrub	3,635	2,317	10,229	10,648	10,135	10,143
Moist prostrate dwarf scrub	2,371	2,818	23,962	12,951	11,098	12,336
Mesic erect dwarf scrub	5,712	3,613	15,309	16,603	32,827	15,815
Very wet graminoid	4	23	35	105	48	100
Wet graminoid	947	13,82	7,204	6,351	4,345	6,050
Moist-wet tundra complex	978	1,614	9,294	7,417	8,496	7,065
Moist graminoid tussock	837	1,896	15,927	8,710	15,385	8,297
Barren floodplain	1,205	409	5,143	1,879	685	1,790
Barren scree	2,910	2,322	5,931	10,672	4,493	10,166
Scarcely vegetated floodplain	301	110	1,934	503	333	479
Scarcely vegetated scree	2,124	1,912	5,282	8,785	5,731	8,368
Clear water	5	52	27	241	137	229
Offshore water	0	1,500	0	6,894	1,381	6,567
Snow-ice-clouds	99	1,424	248	6,545	158	6,235
Shadow	1,446	1,231	3,499	5,656	3,818	5,388

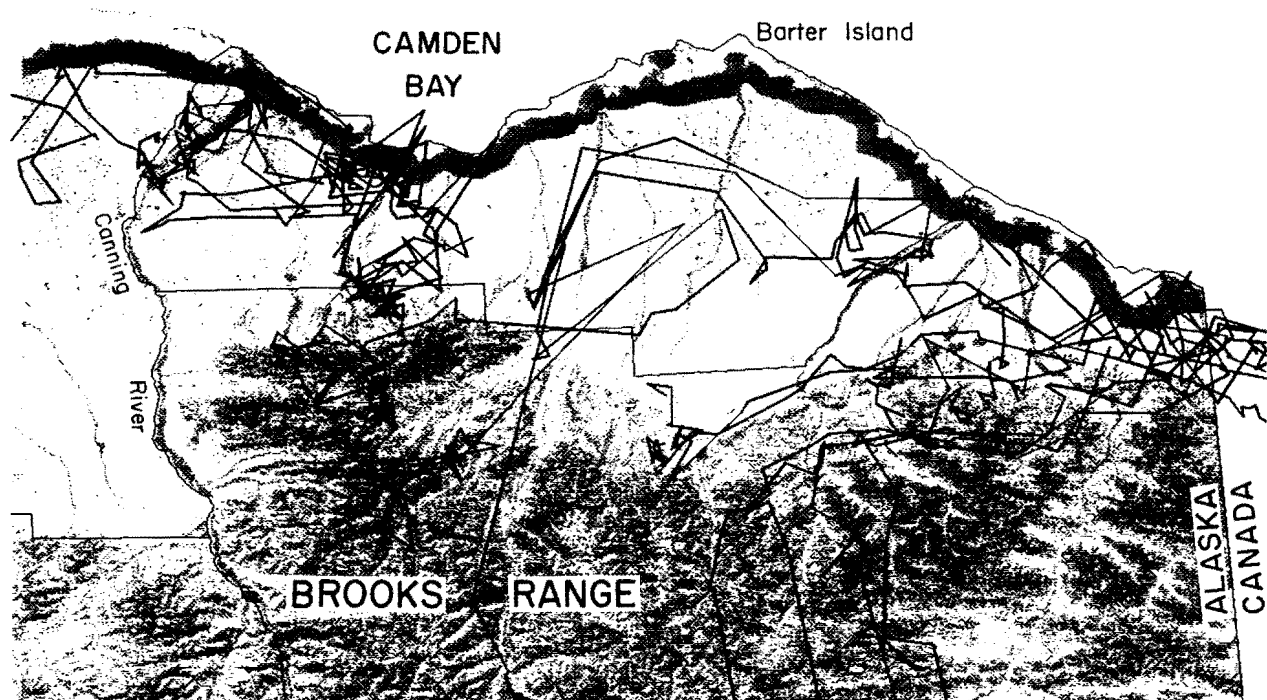

Fig. 47. Movements of radio-collared caribou in relation to insect relief areas (shaded) on the coastal plain of the Arctic National Wildlife Refuge, Alaska, between 15 June and 20 August 1985. Insect relief areas include barren, scarcely vegetated and dry habitats, lakes, and areas within 3 km of the coastline.

Appendix A. Description of Software Package for Processing Argos Data

We developed computer programs and an automated process for entering the large quantity of satellite telemetry into our GIS. All programs are in ANSI standard FORTRAN 77 and were written for maximum portability between different models of computer. Our processing stream also includes some system utilities for sorting records; these are specific to the Data General computers we use, and other users will need to substitute their own utilities for certain steps in the procedure. The programs described here are available for the cost of reproduction to researchers using the Argos DCLS for wildlife studies. To obtain copies of the source code and program listings, send a 5-1/4" diskette and a list of desired programs to Dr. Steve Fancy, U.S. Fish & Wildlife Service, Alaska Fish & Wildlife Research Center, 101 12th Avenue, Box 20, Fairbanks, AK 99701. Requests should include a description of the user's study, including the species being

monitored, study area, number of transmitters deployed, and principal investigators. The desired diskette format (i.e., single- or double-sided, number of sectors) should be included with the request.

The job stream outlined in Fig. 38 utilizes four FORTRAN programs and a sorting utility to process Dispose file data (from either 9-track tape or via modem) for entry into our GIS. Users not having access to a GIS can still use these programs, with some modification, for other purposes. The 200-character output records from ARGOS1.F77 (or ARGOSUS.F77 for data collected after 1 April 1987) are read by other programs (Table A.1), and analyses of location accuracy and precision and summarization of the quantity of data received can be conducted without access to a GIS. The source programs include numerous comments, and additional documentation and test data sets are available.

Table A.1. *Summary of programs for processing satellite telemetry data.*

TRACK.F77	Predicts satellite overpasses and calculates satellite azimuth, elevation, and range for each minute the satellite is above the horizon. Gives frequency distribution of satellite overpasses over a given site by hour. Can be used to determine optimum duty cycle for any location.
EDITPTT.F77	Calculates third-order polynomial regressions for converting temperature sensor output to degrees Celsius for each platform transmitter terminal (PTT). Menu-driven program also stores number of active PTT's, upper and lower limits to user-defined area of interest, and valid PTT numbers for each program.
SUBSET.F77	Extracts portions of files written with or without delimiters (data-sensitive or fixed-length format) for output to another disk file or the line printer. Provides output in byte format for debugging and will output 200-character records as two 100-character records for printing.
COMSUM.F77	Reads up to 10 Ajour files and converts locations to degrees, min and sec for plotting on maps. Calculates distance and azimuth of movements between successive locations and summarizes location and sensor output.
ARGOS1.F77	Reads Dispose files created before 1 April 1987 and summarizes each overpass in a single 200-character record. Data from a single overpass received as two downlinks are combined. Calculates statistics for sensor data and determines those locations that are within the area of interest.
ARGOSUS.F77	Similar to ARGOS1.F77 but used with Dispose files created after 1 April 1987.
VECTORS.F77	Calculates distance and azimuth between successive locations for each animal and writes import files and multiple attribute files for input into the Map Overlay and Statistical System (MOSS; point and line files). Identifies possible errors and switches from primary to alternate locations if primary location is incorrect.
VECTORSUS.F77	Same as VECTORS.F77 but used with data obtained after 1 April 1987.
VCTMERGE.F77	Merges import and multiple attribute files for vector maps so that they can be resorted chronologically rather than by PTT. This keeps the appropriate multiple attributes with the locations and results in maps being plotted such that the relative movements of different animals can be observed.
IMAGE.F77	Summarizes data for all overpasses received during a time period (e.g., 1 month). Determines mean overpasses per PTT per day, mean hits per overpass when a location is fixed and when not fixed, number of locations by location quality index, frequency of the primary and alternate locations being switched, distance between primary and alternate locations, and direction between primary and alternate locations.
IMAGESUM.F77	Summarizes the monthly results from IMAGE.F77 for a year or longer.
ACCURACY.F77	Determines accuracy and directional bias for known-location transmissions. Calculates mean accuracy for each satellite, regressions of accuracy on temperature, and the number of transmissions received during an overpass, and Hotelling's T^2 for directional bias from the actual location.
CIRCULAR.F77	Computes a circular-circular correlation to determine if the azimuth of an overpass is correlated with the azimuth of the fixed location relative to the actual location.
OP.F77	Compares overpass characteristics (maximum elevation, minimum range) to location accuracy and other parameters.

Appendix B. Data Retrieval

Processing of locations and sensor data following each overpass is performed separately, and results are then combined and distributed to the various users' computer accounts. Results can be distributed to users via telephone modem, telex, biweekly printouts, or monthly 9-track computer tapes. Users retrieving data via telephone modem usually access the Argos computer using the computer networks TYMNET and TRANSPAC. Alaskan users access AlaskaNet to link into TYMNET. In most cases, the telephone link requires only a local call to one of the TYMNET stations. Computer printouts of locational and sensor data are mailed every 2 weeks or monthly by Argos. Nine-track computer tapes in EBCDIC format are sent once each month, usually during the first week of the following month.

Results are usually available to users via telephone modem 4–6 h following the overpass. During a recent 12-month period, 28% of messages received were available to users within 3 h, 52% within 4 h, 74% within 6 h, and 86% within 8 h (Argos 1984). Delays result from message storage on satellite tape recorders before playback to CDA stations (0 to 102 min), time for data relay from the CDA stations to the Argos processing centers (approximately 1 h), and time required for processing of the data by Argos (40 min or more) (Argos 1978). All results are stored on tape by Argos for 3 months following time of reception.

Data received during an overpass are sometimes downlinked in two separate groups that, before 1 April 1987, were analyzed separately. These split overpasses occur when a satellite plays back its tape recorders to a CDA station while continuing to receive messages from PTT's. Messages received after the tapes are played back are recorded and are downlinked during the next pass over a CDA station. We frequently find that one portion of the split overpass contains enough messages to calculate a location, whereas the second portion provides sensor data only. It is also possible to get two different locations for an animal from a single overpass. The programs in Appendix A combine data from these split overpasses before statistics are calculated for the sensor data.

Argos File Types

Three types of data files are available from Argos: the Ajour file, Telex files, and Dispose files. Each user must specify which file types are desired when applying for access to the Argos system. Each Dispose file contains the results of a single satellite overpass. The Dispose files are saved on tape and can be sent to the user as printouts or on computer tapes and are also available through a telephone modem. Each Dispose file is stored in the user's directory for 100 h.

Telex files result from the retention of the most useful or significant sensor data from each Dispose file for each PTT. A Telex file is created for each Dispose file. Each Telex file is available on the system for 100 h. The criteria used to select the most useful sensor data from the Dispose files, in order of importance, are as follows:

- a. Messages with all sensor values within the limits specified by the user in the Sensor Data Processing document are given highest priority.
- b. The message with the highest NF value (number of identical consecutive messages) is retained.
- c. The message with the most recent date and time is selected. If the location is based on combined data from two satellite overpasses, the location is recalculated to correspond to the date and time of the sensor data given in the Telex file.

The Ajour file has the same format as the Telex files and contains the most recent Telex file data for each PTT. The Ajour file is permanently available for consultation and contains data for all PTT's that have transmitted within the previous 30 days. A detailed description of the Ajour, Dispose, and Telex files is given below.

Dispose Files

The Dispose file contains the most detailed locational and sensor data acquired during an overpass. Figure B.1. shows an annotated example of Dispose file records; it is the result of two satellite overpasses. A description of each file entry and its format is given in Table B.1. During the first overpass by satellite number 2 (NOAA-6), sensor data for

Table B.1. *Format of Dispose files created before 1 April 1987.*

Variable	Description	Format	Columns
Line One			
NUMEXP	Experiment number	I5	1-5
NCAR	Number of records for this overpass	I2	8-9
NUMPF	PTT ^a number	I5	11-15
NC	Number of bytes of sensor data	I2	17-18
JOJUL	Days since 1 January 1950	I5	20-24
AN	Year	I2	26-27
JOUR	Julian day for last location	I3	29-31
HEUR	Hour (Universal Time)	I2	33-34
MIN	Minute	I2	36-37
SEC	Second	I2	39-40
ID0 ^b	Location calculation code	I1	42
IB0 ^c	PTT type	I3	44-46
NSAT	Satellite number (1 or 2)	I1	48
H0	Initial altitude of PTT (m)	I6	53-58
F0	Transmission frequency (401,650,000 Hz)	I9	60-68
ISEQ	Record count (base 36)	A3	78-80
Line Two			
NUMEXP	Experiment number	I5	1-5
NLOC ^d	Location quality index	I2	11-12
LAT	Latitude of most recent location (degrees)	F8.3	16-23
LON	Longitude of most recent location (0-360°)	F8.3	25-32
DLAT	Rate of movement (degrees lat. per day) or alternate latitude	F8.3	34-41
DLON	Rate of movement (degrees long. per day) or alternate longitude	F8.3	43-50
H	Computed altitude of PTT	I6	53-58
F	Frequency received by satellite (Hz)	I9	60-68
ISEQ	Record count (base 36)	A3	78-80
Remaining Lines (sensor data)			
NUMEXP	Experiment number	I5	1-5
JOJUL	Days since 1 January 1950	I5	7-11
HEUR	Hour-time of sensor data reception by satellite (UT)	I2	13-14
MIN	Minute	I2	16-17
SEC	Second	I2	19-20
NF	Number of identical consecutive messages	I2	22-23
C1	Byte 1 of sensor data	A10	26-35
C2	Byte 2 of sensor data	A10	39-48
C3	Byte 3 of sensor data	A10	52-61
C4	Byte 4 of sensor data	A10	65-74
ISEQ	Record count	A3	78-80

^aPlatform transmitter terminals.

^bID0: Location calculation code as requested by user:

0 = location not required.

1 = location based on one overpass is acceptable (minimum of five messages separated by 420 sec).

2 = location based on two overpasses essential.

3 = fixes based on only four transmissions separated by 240 sec desired.

^cIB0: PTT type

-1 = low speed (animals, buoys; <20 m/sec).

+1 = high speed (balloons; >20 m/sec).

^dLocation quality index:

-1 = PTT not located; previous location based on only one pass.

0 = PTT not located.

1 = Location based on two overpasses by same satellite.

2 = Location based on two overpasses, one by each satellite.

3 = Location based on one overpass only.

PRV, DS															
(A)	(B)	(C)	(D)	(E)	(F)			(G)							
400	8	2848	4	13449	86	301	17	41	17	3	-1	2	0	401650000	001
400		3(H)		69.674	←	215.000		64.829					0	401649865	002
400	13449	17	38	47	1	066		029						0115	003
400	13449	17	39	47	1	065		242						0115	004
400	13449	17	40	47	1	065		196						0115	005
400	13449	17	41	47	1	065		153						0115	006
400	13449	17	42	47	1	065		105						0115	007
400	13449	17	43	47	1	065		062						0115	008
	(J)						(K)		(L)				(M)		
400	5	2849	4	13448	86	300	19	40	44	3	-1	2	0	401650000	009
400		-1		67.157	212.992			71.520					0	401649752	00A
400	13449	17	38	41	1	047		199						0099	00B
400	13449	17	40	41	1	047		205						0099	00C
400	13449	17	41	41	1	047		200						0099	00D
400	7	2854	4	13449	86	301	19	36	33	3	-1	1	0	401650000	00E
400		2		69.536	213.188			0.031				0.072	0	401649819	00F
400	13449	19	25	33	1	064		112						0241	00G
400	13449	19	28	33	1	065		211						0081	00H
400	13449	19	29	33	1	065		213						0081	00I
400	13449	19	30	33	1	065		200						0081	00J
400	13449	19	34	33	1	065		195						0081	00K

Fig. B.1. Example of an Argos Dispose file written before 1 April 1987, containing data for 3 platform transmitter terminals (PTT's). The symbols represent the following parameters: A = program number; B = number of records for this PTT during the overpass; C = PTT number; D = number of sensors; E = number of days since 1 January 1950; F = date and time for which the location on line 2 was calculated (halfway through overpass), including the year, Julian day, hour, minute, and second; G = satellite number (1 or 2); H = location quality index (3 = location based on a single overpass); I = latitude and east longitude of primary and alternate locations; J = date and time when this particular message was received; K = temperature data; L = short-term activity index; M = long-term activity index; N = latitudinal and longitudinal components of movement vector between two adjacent locations.

PTT's 2848 and 2849 were received, but a location was fixed only for PTT 2848. Note that the date and time shown in line 1 of each overpass corresponds to the location shown in line 2 and does not necessarily represent the time of the overpass. Six consecutive transmissions from PTT 2848 were received by NOAA-6, and from this single overpass the caribou's position was fixed at either 69.674N latitude 145W longitude (360 minus 215) or 64.829N 117.206W. The second solution to the location algorithm, that is, the location's image, is known to be incorrect based on previous locations and the known range of the Porcupine Caribou Herd. The data for PTT 2848 indicate an internal PTT temperature of approximately -0.3°C , and the activity data indicate that the caribou was lying quietly during the overpass (see *Sensor Development and Calibration*).

Three transmissions by PTT 2849 were received by NOAA-6 during the same overpass, but no location was calculated as indicated by the location qual-

ity index of -1 (Fig. B.1.). The locations appearing in the second line for PTT 2849 were calculated from data received the previous day at 1940 UT. The third Dispose file entry is based on combined data from NOAA-6 and NOAA-9, both of which were in view of PTT 2854 at approximately 1930 UT on 28 October 1986 (Julian day 301). Because more than one satellite overpass was involved, Argos was able to calculate a location and velocity vectors for the caribou. Thus, at 1936 UT on day 301, caribou 2854 was located at 69.536N 146.812W and was moving north at 0.031 degrees latitude per day and east at 0.072 degrees longitude per day. The activity data indicate that this caribou was browsing or grazing during the overpass.

Telex Files

If requested by the user, one Telex file is created from each Dispose file. The formats of the Telex and Ajour files are identical, as described later.

```

/COM,0400,PASS,ALL
EXP 0400
02848 69.674N 145.000W OR 64.829N 117.206W 301/1743Z-
(F) (1) 065 ← 062 ← (G) → 00 → 0115
02849 67.157N 147.008W OR 71.520N 170.836W 301/1741Z-300/1940
(1) 047 200 08 (I) 0099
02854 69.536N 146.812W 0.031N 0.072E 301/1934Z-
(1) 065 195 15 0081

ARGOS READY

/

```

Fig. B.2. Example of the Ajour file resulting from the Dispose file data shown in Fig. B.1. Symbols represent A = program number; B = platform transmitter terminal number; C = primary location; D = alternate location; E = Julian date and time when most recent sensor data were received; F = number of identical records received; G = sensor data (temperature and activity) for most recent message; H = Julian date and time for most recent location; I = movement rate (degrees/day).

Ajour File

The Ajour file, also referred to as the COM file, contains the most recent Telex entry for each PTT that has transmitted within the previous 30 days. This file is updated as soon as the processing for each overpass is completed and can be consulted repeatedly without affecting the file.

The example in Fig. B.2. shows the output of the Ajour file following the compaction and updating of Dispose file data shown in Fig. B.1. The Telex file associated with the Dispose file example in Fig. B.1. would also appear as in Fig. B.2. Note that the date and time of the entry for PTT 2848 in the Ajour file (301/1743Z) is based on the last line of sensor data in the Dispose file and that the sensor data appearing in the Ajour file is also from the last line of the Dispose file. The entry for PTT 2849 shows two dates and times because sensor data were last received at 1741 UT on day 301, but the last locational fix was at 1940 UT on day 300. The third entry, for PTT 2854, is based on data from more than one overpass (i.e., velocity vectors are given in place of a second solution to the location algorithm).

Argos Commands

The Argos computer recognizes 10 commands for accessing and retrieving data from its data banks.

All of these commands, with the exception of PASS, can be reduced to one letter. A short description of the commands is as follows:

LOGIN	Connection to the Argos computer.
LOGOUT	Ends a session and disconnects from the computer.
COM	Lists Ajour file for a program.
PRV	Lists Dispose or Telex files.
NEWS	Summarizes waiting mail messages.
READ	Displays one or more mail messages from the Argos Processing Center (APC).
MESS	Allows user to send a message to the APC.
PASS	Allows user to change the four-character program password.
I	Suspends data transmission until a carriage return is sent.
HELP	Displays detailed information on each command.

In the following descriptions of each command, optional parameters are enclosed in parentheses. Each command line must be followed by a carriage return.

LOGIN. A valid USERNAME and PASSWORD provided by Service Argos must be entered to gain access to the Argos computer. The 6-character

password is provided to Argos in the initial application forms and can only be changed by the APC. The following shows a typical login using the AlaskaNet and TYMNET computer networks.

```

please type your terminal identifier A
Welcome to AlaskaNet
-2021:01-002-
please log in: SERVICEARGOS;ARGOS.02
remote network [sf]: call connected via san francisco gateway:
Username: NAME
Password: PASSWD
WELCOME TO THE UNITED STATES
  ARGOS PROCESSING CENTER
LOGIN AT 303/2225  LAST ACCESS AT 302/
  1812 GMT
ARGOS READY
/

```

In this example, the user logged onto the Argos computer on Julian day 303 (30 October) at 2225 h Universal Time. The user's last session was the previous day at 1812 h UT.

COM. The COM command is used to list all or part of the Ajour file for a program. The format of the command is

```

/COM, (pppp), (pass), (ALL)
                    (PART)
                    (PPPPP(PPPPP,...))

```

where: *pppp* is the program number, *pass* is the 4-character password for the program, and PPPPP is a specific PTT or range of PTTs for which data are requested. This parameter can be excluded if the user desires all data for the program. Leading zeroes should not be entered. Users requesting data for their own program can exclude the program number and password.

Some examples of the COM command are:

```

/COM,,,ALL
  Lists the most recent location and sensor data
  for each PTT in the program.
/COM,,,2845-2849,2854
  Lists data for PTT's 2845 through 2849 and
  for 2854.
/COM,0401,PASS,ALL
  Lists Ajour file for a program belonging to
  another user (program 401).
/COM,,,PART
  Lists all data for a program that have been up-
  dated since the last consultation.

```

PRV. The PRV command is used to display all or part of the data stored in the Telex and Dispose files. Each Telex or Dispose file represents data received during one satellite overpass. The format of the command is:

```

/PRV, (pppp), DS, (DDD/HH - DDD/HH),
  (PPPPP(PPPPP,...))

```

or

```

/PRV, (pppp), TX, (DDD/HH - DDD/HH),
  (PPPPP(PPPPP,...))

```

where: *pppp* is the program number, which can be excluded if the requested files belong to the user; DS or TX represents the type of file (Dispose or Telex) requested; DDD/HH is the starting and ending Julian date and UT used to list Dispose or Telex files, and PPPPP is a list or range of PTT's.

Some examples of the PRV command are:

```

/PRV,,DS

```

Lists all Dispose files for a program for the current Julian day.

```

/PRV,,DS,072/14

```

Lists data for one overpass contained in Dispose file 072/14.

```

/PRV,0400,TX

```

Lists all Telex files for program 0400.

```

/PRV,,DS,240-243,2850-2854,2870

```

Lists Dispose files for PTT's 2850 through 2854 and for PTT 2870, between days 240 and 243.

NEWS. The NEWS command lists the time and subject of all waiting messages from the Argos Processing Center. The content of the messages must be read using the READ command. An example of the command is:

```

/NEWS

```

#	FROM	DATE	SUBJECT
1	USEROFFICE	1-NOV-1986	Simplified orbital parameters
2	USEROFFICE	2-NOV-1986	Experiment 0400

READ. This command is used to list one or more waiting messages from the APC. The format is:

```

/READ,(num)

```

where: *num* is the message number listed with the NEWS command.

All messages will be listed if READ is entered without specifying any numbers. Once a message has been read, it is deleted from the user's account.

MESS. The MESS command is used to send a message to the APC. The user enters the subject and text of the message, then ends the message with a line containing only a period. At this point, the prompt **SEND (Y/N):** will appear. If N is entered, the message will be cancelled. An example of the MESS command is:

/MESS

SUBJECT: Program 0400

TEXT:

Please transfer PTTs 5690 and 5691 to program 0401. Thank you.

SEND (Y/N): Y

PASS. This command allows the user to change the four-character password for a program. This is the only command where all four letters are mandatory. The format of the command is:

/PASS,*pppp*

where *pppp* is the program number.

The user will then be asked to enter the old and new passwords. Example:

/PASS,0400

OLD PASSWORD:PASS

NEW PASSWORD:NEWP

REENTER NEW PASSWORD:NEWP

PASSWORD has been changed.

I. The I command is used to interrupt (pause) the flow of data being sent to the user. It does not cancel the previous command, nor can it be used to correct errors. A delay of one or more minutes may occur between the time the I key is hit and the time that data transmission is suspended. The transmission of data is restarted by hitting the return key.

HELP. HELP gives detailed information on the 10 available commands and their formats. If HELP or a ? is entered by itself, a list of the 10 commands is given. The command format is:

/HELP(*command*)

Examples:

/HELP

/? ,COM

/HELP,PRV

Appendix C. Explanation of Satellite Orbital Elements

The orbital elements contained in the NASA prediction bulletins are used as input to computer programs for predicting satellite overpasses. This section, based primarily on Brooks (1977), is intended to give an overview of orbital mechanics and to explain the various terms used in making overpass predictions.

Figure C.1. shows the position of a satellite at point P in its orbit around the earth. The hatched

area is the orbital plane of the satellite above the earth's surface. Note that the X and Y axes of this earth-central Cartesian coordinate system are contained within the earth's equatorial plane. The X axis is defined by the vector pointing from the earth to the sun at the moment of the vernal equinox. The right ascension of the ascending node Ω and the inclination i position the orbital plane of the satellite in space. The inclination is the angle between the satellite's orbital plane and the earth's equatorial plane, which is approximately 98.8° for the Tiros-N satellites. Two other orbital elements, the argument of perigee ω and the true anomaly f , specify the angular position of the satellite at point P along its orbital path relative to the equatorial plane. Perigee is the point of the satellite's closest approach to the center of the earth, whereas the satellite is farthest from earth at apogee. The mean of the radii from the earth's center to the orbit's perigee and apogee is the semimajor axis of the orbit. The eccentricity e is a dimensionless measure of the departure from a circular orbit of radius a . These six Keplerian elements—right ascension of the ascending node, inclination, argument of perigee, true anomaly, semimajor axis, and eccentricity—together specify the position and velocity of the satellite. The prediction bulletins report the mean anomaly for the satellite rather than the true anomaly, because the anomalistic period is not constant for elliptical orbits. Another orbital parameter given in the prediction bulletins is the mean motion, which is simply the number of orbits made by the satellite in one day.

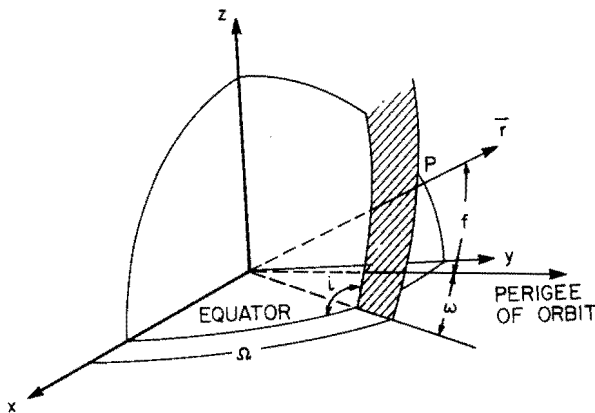

Fig. C.1. Explanation of satellite orbital elements used to describe the position of an earth-orbiting satellite at point P. The orbital plane of the satellite is described by the right ascension of the ascending node Ω and the inclination i . The argument of perigee ω and the true anomaly f specify the angular position of the satellite along its orbital path relative to the equatorial plane.

Appendix D. Glossary

- Anomalistic Period of Satellite** The time elapsing between successive passages of a satellite through the perigee.
- Apogee** The point in its orbit at which the satellite is farthest from the center of the earth.
- Argument of Perigee** The geocentric angle of the perigee measured in the orbital plane from its ascending node in the direction of motion.
- Ascending Node** The point at the equator at which the satellite in its orbital motion crosses from the southern to the northern hemisphere.
- Azimuth** A horizontal direction expressed in degrees measured clockwise from an adopted reference direction, usually true north.
- Beacon** Source of real-time transmission of data from satellite instruments on either VHF or S-band frequencies. Also refers to conventional VHF transmitter used with an animal PTT.
- Command and Data Acquisition Station (CDA)** A ground station at which various functions to control satellite operations and to obtain data from the satellite are performed. The CDA station transmits programming signals to the satellite and commands transmission of data to the ground.
- DCLS** Data Collection and Location System.
- Descending Node** The southbound equatorial crossing of the satellite; given in degrees longitude, date, and time for any given orbit or pass.
- Downlink** Transmission of satellite data to a ground station.
- Duty Cycle** Programmed pattern of active-inactive periods for a transmitter. A PTT programmed with a duty cycle of 6 h on-18 h off and having a repetition interval of 55 sec will transmit every 55 sec during the same 6-h period each day.
- GIS** Geographic Information System. Computer software used to analyze and display spatially oriented data.
- HRPT** High-Resolution Picture Transmission. Contains Argos DCLS data as well as weather imagery and data from other satellite instruments and is transmitted by the satellite in real-time and via tape playback to CDA stations.
- Inclination** The angle between the plane of the satellite orbit and the earth's equatorial plane.
- LUT** Local User Terminal. A computerized system that receives real-time transmissions from satellites above the horizon and processes Argos data contained within the transmitted signal. Also known as direct readout stations.
- Nodal Increment** Degrees of longitude between successive ascending nodes.
- Nodal Period** The time elapsing between passages of the satellite through successive ascending nodes.
- Orbital Plane** The plane or two-dimensional space that contains the path of an orbiting satellite.
- Polar Orbit** An orbit that passes directly over both the geographic poles.
- PTT** Platform Transmitter Terminal. Term used by Service Argos to refer to Argos-compatible transmitters.
- Right Ascension** The arc measured eastward along the celestial equator from the vernal equinox to the great circle passing through the celestial poles and the object projected onto the celestial sphere.
- S-band** Range of frequencies (e.g., 1698, 1702.5, 1707 MHz) used to downlink satellite data.
- Sun-synchronous Orbit** Nominally a retrograde, quasi-polar orbit such that the satellite crosses the equator on the ascending node at approximately the same local (solar) time each day.
- TIP Data** Data from the Tiros Information Processor, which includes Argos messages as well as information from other instruments onboard the satellite.
- Universal Time (UT)** Greenwich Mean Time.
- Uplink** Transmission of data from an Argos-compatible transmitter or ground station to the satellite.
- VSWR** Voltage Standing Wave Ratio. Reduction of effective radiated power through an antenna caused by reflectance of power off a large mass close to the antenna. Can result in loss of data because transmission is not received by the satellite.

Appendix E. Getting Started with Argos

Potential users interested in obtaining additional information on using the Argos system should write to or call Service Argos (United States office) at Service Argos, Inc., 1801 McCormick Drive, Suite 10, Landover, MD 20785, telephone (301) 925-4411.

Potential users should request the Argos User's Guide (Argos 1984), tariff information, and a program application form. Users admitted into the program should also request a technical file and detailed technical documents on data dissemination and sensor data processing.

Payment to Service Argos for data processing and use of the system can be made by one of two means: a purchase order directly to Service Argos or payment through the global agreement, in which each country provides a single payment to Service Argos to cover the processing charges for all users contributing to that country's agreement with Argos. In the former case, Service Argos will bill the user for the number of PTT-years of processing used, plus the cost of printouts or magnetic tapes sent to the user. Users contributing to the global agreement pay a lower amount (approximately one-third of commercial rate) for processing, but the number of PTT-years of processing for the next calendar year must

be anticipated and the amount to cover the processing must be paid in advance. The cost of printouts and tapes is billed by Service Argos outside the global agreement and a purchase order is required for each user. Furthermore, only certain governmental and nonprofit entities are included in the global agreement. The cost for 1 PTT-year of processing for users contributing to the United States Global Agreement is approximately \$3,200-\$3,400 and will vary each year depending on the number of PTT-years and Argos' operating costs. The number of PTT-years used depends on the number of active PTT's and their duty cycles. Two PTT's transmitting on alternate days would constitute 1 PTT-year. If 10 PTT's each transmitted every other day, the user would pay for 5 PTT-years of processing.

Information on the U.S. Global Agreement between NOAA and the French space agency CNES to cover charges for platform location and data processing services associated with the Argos system can be obtained from the National Oceanic and Atmospheric Administration, Office of Climatic and Atmospheric Research, NOAA-R/CAR, Rockville, MD 20852, Attn: Mr. Terry Bryan.

Fancy, Steven G., Larry F. Pank, David C. Douglas, Catherine H. Curby, Gerald W. Garner, Steven C. Amstrup, and Wayne L. Regelin. 1988. **Satellite Telemetry: A New Tool for Wildlife Research and Management.** U.S. Fish Wildl. Serv., *Resour. Publ.* 172. 54 pp.

The Argos Data Collection and Location System can be used to systematically acquire detailed locational and behavioral data from animals via satellite. System components, applications of satellite technology to wildlife research and management, and use of geographic information systems are described. A computer software package for analyzing satellite telemetry data is presented.

Key words: Telemetry, satellite, animal movements, geographic information systems, caribou, polar bears, Alaska, animal tracking.

Fancy, Steven G., Larry F. Pank, David C. Douglas, Catherine H. Curby, Gerald W. Garner, Steven C. Amstrup, and Wayne L. Regelin. 1988. **Satellite Telemetry: A New Tool for Wildlife Research and Management.** U.S. Fish Wildl. Serv., *Resour. Publ.* 172. 54 pp.

The Argos Data Collection and Location System can be used to systematically acquire detailed locational and behavioral data from animals via satellite. System components, applications of satellite technology to wildlife research and management, and use of geographic information systems are described. A computer software package for analyzing satellite telemetry data is presented.

Key words: Telemetry, satellite, animal movements, geographic information systems, caribou, polar bears, Alaska, animal tracking.

Fancy, Steven G., Larry F. Pank, David C. Douglas, Catherine H. Curby, Gerald W. Garner, Steven C. Amstrup, and Wayne L. Regelin. 1988. **Satellite Telemetry: A New Tool for Wildlife Research and Management.** U.S. Fish Wildl. Serv., *Resour. Publ.* 172. 54 pp.

The Argos Data Collection and Location System can be used to systematically acquire detailed locational and behavioral data from animals via satellite. System components, applications of satellite technology to wildlife research and management, and use of geographic information systems are described. A computer software package for analyzing satellite telemetry data is presented.

Key words: Telemetry, satellite, animal movements, geographic information systems, caribou, polar bears, Alaska, animal tracking.

Fancy, Steven G., Larry F. Pank, David C. Douglas, Catherine H. Curby, Gerald W. Garner, Steven C. Amstrup, and Wayne L. Regelin. 1988. **Satellite Telemetry: A New Tool for Wildlife Research and Management.** U.S. Fish Wildl. Serv., *Resour. Publ.* 172. 54 pp.

The Argos Data Collection and Location System can be used to systematically acquire detailed locational and behavioral data from animals via satellite. System components, applications of satellite technology to wildlife research and management, and use of geographic information systems are described. A computer software package for analyzing satellite telemetry data is presented.

Key words: Telemetry, satellite, animal movements, geographic information systems, caribou, polar bears, Alaska, animal tracking.

A list of current *Resource Publications* follows.

157. The Breeding Bird Survey: Its First Fifteen Years, 1965-1979, by Chandler S. Robbins, Danny Bystrak, and Paul H. Geissler. 1986. 196 pp.
158. Techniques for Studying Nest Success of Ducks in Upland Habitats in the Prairie Pothole Region, by Albert T. Klett, Harold F. Duebbert, Craig A. Faanes, and Kenneth F. Higgins. 1986. 24 pp.
159. Research and Development Series: An Annotated Bibliography, 1889-1985, compiled by Thomas J. Cortese and Barbara A. Groshek. 1987.
160. Manual of Acute Toxicity: Interpretation and Data Base for 410 Chemicals and 66 Species of Freshwater Animals, by Foster L. Mayer and Mark R. Ellersieck. 1986. 579 pp.
161. Interpretation and Compendium of Historical Fire Accounts in the Northern Great Plains, by Kenneth F. Higgins. 1986. 39 pp.
162. Population Ecology of the Mallard. VIII. Winter Distribution Patterns and Survival Rates of Winter-Banded Mallards, by James D. Nichols and James E. Hines. 1987. 154 pp.
163. Forested Wetlands of the Southeast: Review of Major Characteristics and Role in Maintaining Water Quality, by Parley V. Winger. 1986. 16 pp.
164. Effects of Contaminants on Naiad Mollusks (Unionidae): A Review, by Marian E. Havlik and Leif L. Marking. 1987. 20 pp.
165. Marking and Tagging of Aquatic Animals: An Indexed Bibliography, by Lee Emery and Richard Wydoski. 1987. 57 pp.
166. Checklist of Vertebrates of the United States, the U.S. Territories, and Canada, by Richard C. Banks, Roy W. McDiarmid, and Alfred L. Gardner. 1987. 79 pp.
167. Field Guide to Wildlife Diseases. Vol. 1. General Field Procedures and Diseases of Migratory Birds, by Milton Friend, Cynthia J. Laitman, and Randy Stothard Kampen. 1987. 225 pp.
168. Mourning Dove Nesting: Seasonal Patterns and Effects of September Hunting, by Paul H. Geissler, David D. Dolton, Rebecca Field, Richard A. Coon, H. Franklin Percival, Don W. Hayne, Lawrence D. Soileau, Ronnie R. George, James H. Dunks, and S. Dwight Bunnell. 1987. 33 pp.
169. Saltcedar Control for Wildlife Habitat Improvement in the Southwestern United States, by Theodore A. Kerpez and Norman S. Smith. 1987. 16 pp.
170. Pesticide Use and Toxicology in Relation to Wildlife: Organophosphorus and Carbamate Compounds, by Gregory J. Smith. 1987. 171 pp.
171. Sand and Gravel Pits as Fish and Wildlife Habitat in the Southwest, by William J. Matter and R. William Mannan. 1988. 11 pp.

NOTE: Use of trade names does not imply U.S. Government endorsement of commercial products.

As the Nation's principal conservation agency, the Department of the Interior has responsibility for most of our nationally owned public lands and natural resources. This includes fostering the wisest use of our land and water resources, protecting our fish and wildlife, preserving the environmental and cultural values of our national parks and historical places, and providing for the enjoyment of life through outdoor recreation. The Department assesses our energy and mineral resources and works to assure that their development is in the best interests of all our people. The Department also has a major responsibility for American Indian reservation communities and for people who live in island territories under U.S. administration.



UNITED STATES
DEPARTMENT OF THE INTERIOR
FISH AND WILDLIFE SERVICE
OFFICE OF INFORMATION TRANSFER
1025 PENNOCK PLACE, SUITE 212
FORT COLLINS, COLORADO 80524

THIRD-CLASS MAIL
POSTAGE AND FEES PAID
U.S. DEPARTMENT OF THE INTERIOR
PERMIT NO. G-77

NOTE: Mailing lists are computerized. Please return address label with change of address.